



INSTALLATION GUIDE

CABLOFIL[®]

 legrand[®]



EXTERIOR INSTALLATION

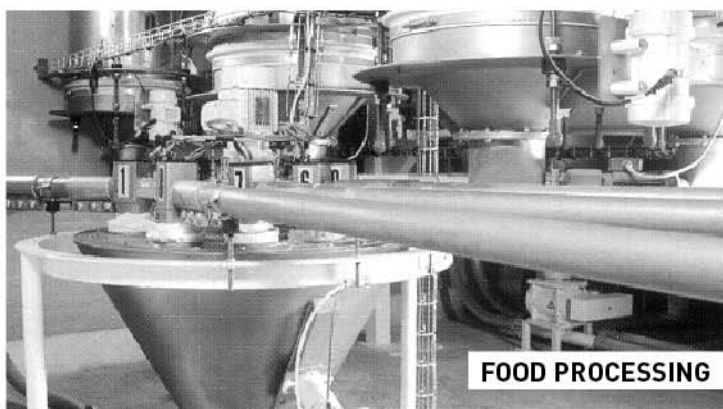

FOOD PROCESSING



UNDERFLOOR INSTALLATION



INTERIOR INSTALLATION



INDUSTRIAL PLANT

CABLOFIL WIRE MESH TRAY

Cablofil, the inventor of wire mesh cable tray is a revolutionary cable management system that provides exceptional strength combined with the flexibility to adapt easily to field requirements. Installation is easier since wire mesh requires fewer parts and the FAS system allows splice, bracket and accessory connections without hardware! Manufactured in the heartland of the US, Cablofil is dedicated to providing superior quality product, service and expertise.

INDEX
INSTRUCTIONS

FINISHES	4
HOW TO CUT CABLE TRAY	5
HOW TO SPLICE CABLE TRAY	6
FASLOCK DIRECTIONAL CHANGES	7
T JUNCTIONS: RAD T 90 KIT	8
T JUNCTIONS: EZ T 90 KIT	9
90° BENDS: RAD T 90 KIT	10
90° BENDS: EZ T 90 KIT	11
Y JUNCTIONS	12
90° JUNCTIONS	13
SWEEPS - SWK	14
SWEEPS - FASLOCK	15
REDUCTIONS	16
CHANGING LEVELS	16
BONDING AND GROUNDING	17
LOADING	17
SUPPORT SPACING	17-18

PRODUCTS

TRAY	19
TRAY COVERS	19
SPLICING	19-20
ACCESSORIES	20
WALL MOUNTINGS	21
CEILING MOUNTINGS	21-22
UNDER FLOOR MOUNTINGS	22
OTHER MOUNTING	23

FINISHES

Cablofil wire cable tray and accessories are available in a variety of finishes to meet any industry need, from decorative to extreme environments. Use this chart to help you determine the best finish for your application and its availability.

Standard finish is EZ, electroplated zinc. (indoor applications)
 Stock finishes available include (EZ), electroplated zinc, (316L), 316 stainless steel, (GC), Hot dipped galvanized, (BL) Black powder coat paint

SYMBOL	MATERIAL	FINISH & STANDARD	Interior installations	Exterior installations	Petroleum Plants Chemical Plants	Marine/salt, Weak sulphurous environments	Acidic, alkaline environments	Food Production, Wash-down, Clean rooms	Halogen environments
PG	Carbon Steel ASTM A653	Pre-Galvanized: Continuous Galvanization Before Fabrication ASTM A 653	●						
EZ	Carbon Steel ASTM A510 Grade 1008	Electrozinc: Electrozinc plating ASTM B 633	●						
GC	Carbon Steel ASTM A510 Grade 1008	Hot Dipped Galvanized: After Fabrication ASTM A 123		●	●	●	●		
DC	Carbon Steel ASTM A510 Grade 1008	Dacromet: Zinc and Aluminum Protection Equivalent to Hot Dip Galvanization ASTM F 1136		●	●	●	●		
304L	Stainless Steel AISI Type 304L	Stainless Steel 304L: Cleaned and Passivated ASTM A 380		●	●	●	●	●	●
316L	Stainless Steel AISI Type 316L	Stainless Steel 316L: Cleaned and Passivated ASTM A 380		●	●	●	●	●	●
BL	Carbon Steel ASTM A510 Grade 1008	Black Painted: Black Powder Coated ASTM D 3451	●						
PE	Carbon Steel ASTM A510 Grade 1008	Custom Painted: Custom Color Powder Coated ASTM D 3451	●						

● recommended ● possible

For a more detailed explanation of finish standards and compatibility, visit www.cablofil.com.

HOW TO CUT CABLOFIL CABLE TRAY

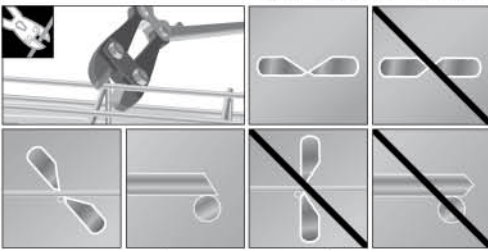
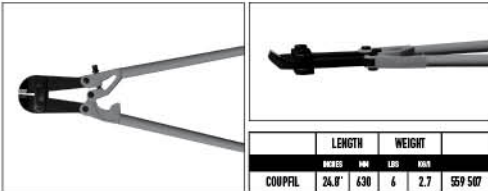

- Always use side action bolt cutters.
- Angle all cuts away from the new end.
- Cut each wire with one clean cut – eliminating any grinding or touch-up.

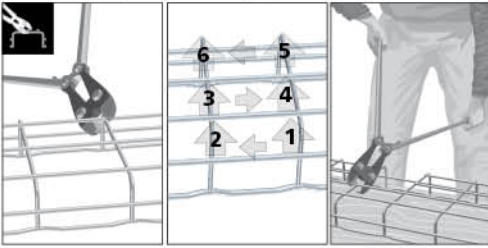

- Cut the bottom wires first, in order as shown, from the underside of the tray.
- Rest the lower jaw of the cutters against the cradle wire and cut at an angle away from the new end.

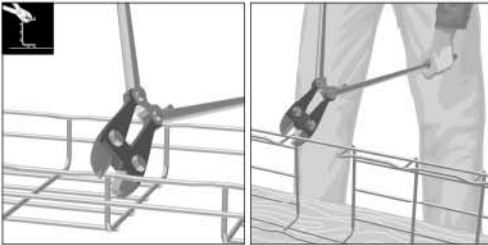

- Cut the side wires next, starting with the top wire.
- Make sure the finished cut is safe and ready for installation.

USING A POWER CUTTER TO CUT CABLOFIL CABLE TRAY



cutyfil

	WEIGHT		
	LB	KG	
CUTYFIL	9.5	4.3	559 557
REPLACEMENT BLADES	4	2	559 577
BATTERY	1	5	559 567
CHARGER	2	9	559 558



Cutyfil from Cablofil makes cutting wire cable tray easy. This lightweight power tool features a 330° swivel cutting head to make cuts from any angle. One button control engages and retracts blade for each cut. Cutyfil Kit comes in a padded carrying case with 2 batteries and a charger.



Use the same cutting procedures as outlined on the previous page when using Cutyfil. Remember to always wear safety goggles and follow safe procedures when using power equipment.

HOW TO SPLICE CABLOFIL CABLE TRAY – EDRN

SPLICING GUIDELINES



CF30 – CF54 – CF105 – CF150	2" (50 mm)	12" (300 mm)	18" → 24" (450 → 600 mm)
 EDRN splices needed on side wires	2x EDRN	2x EDRN	2x EDRN
 EDRN splices needed on bottom of tray	-	-	1x OR 2x EDRN

INSTRUCTIONS



HOW TO SPLICE CABLOFIL CABLE TRAY – PRECLICK

SPLICING GUIDELINES

CF54 – CF105 – CF150	2" → 8" (50 → 200 mm)	12" (300 mm)	18" → 24" (450 → 600 mm)
 PRECLICK splices needed on side wires	2x PRECLICK	2x PRECLICK	2x PRECLICK
 SWK splices needed on bottom of tray	-	1x SWK	2x SWK

INSTRUCTIONS

Step 1-3: Snap a PRECLICK on each length of Cablofil tray to be joined.

Step 4: Snap in place with a screw driver or a simple "TAP" on the end.

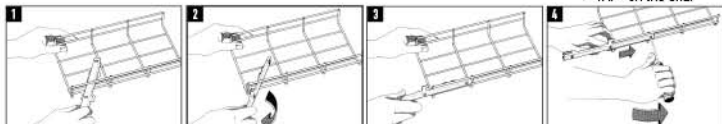

Step 5: Join both lengths of Cablofil tray and snap in place. (two options)

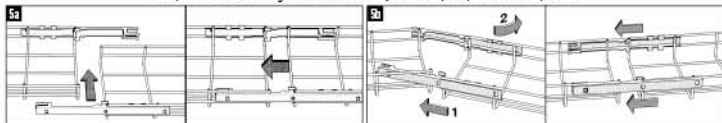

Removing PRECLICK: Use a screw driver to remove PRECLICK

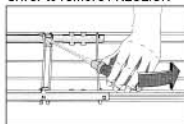

HOW TO SPLICE CABLOFIL CABLE TRAY - SWK

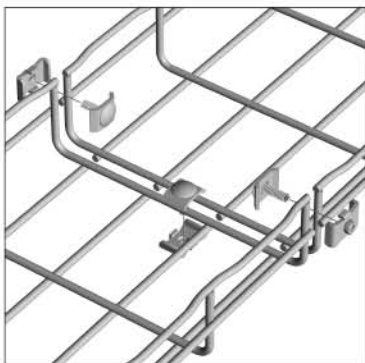

- Use SWK to splice any two sections of Cablofil tray.
- Swaged nut allows clamp to be stationary while nut is tightened.
- Consult chart below for correct number of SWK sets needed for each width of tray.

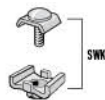

CF30 – CF54 – CF105 – CF150	2" (50 mm)	4" → 8" (100 → 200 mm)	12" → 24" (300 → 600 mm)
 SWK attachment sets needed for side wires	2x SWK	2x SWK	2x SWK
 SWK attachment sets needed for bottom wires	-	1x SWK	2x SWK

HOW TO SPLICE CABLOFIL CABLE TRAY - CE 25, CE 30

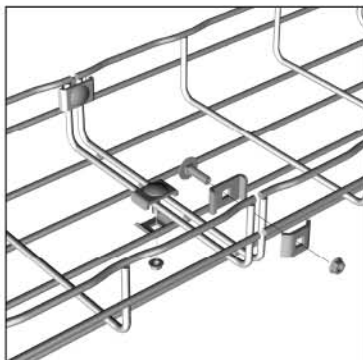

- Use CE 25 and CE 30 with EZ BN 1/4 to splice any two sections of Cablofil tray.
- Consult chart below for correct number of Nut/ Bolt/Clamp sets needed for each width of tray.

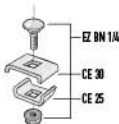

	CF30 – CF54 – CF105 – CF150	2" (50 mm)	4" → 8" (100 → 200 mm)	12" → 24" (300 → 600 mm)
→ ← CE 25-CE30 attachment sets needed for side wires		2x CE 25, CE 30, EZ BN 1/4	2x CE 25, CE 30, EZ BN 1/4	2x CE 25, CE 30, EZ BN 1/4
↑ CE 25-CE30 attachment sets needed for bottom wires		-	1x CE 25, CE 30, EZ BN 1/4	2x CE 25, CE 30, EZ BN 1/4

DIRECTIONAL CHANGE HARDWARE

90 DEGREE BENDS

TRAY WIDTH	FASLOCK (SWEEP)		SWK (SWEEP)		RADT90		EZT90	
	QTY. REQUIRED	CUT INSTRUT.	QTY. REQUIRED	CUT INSTRUT.	QTY. REQUIRED	CUT INSTRUT.	QTY. REQUIRED	CUT INSTRUT.
2"	-	-	2	p. 15	-	-	1 kit	p. 11
4"	2	p. 14	2	p. 15	1 kit	p. 10	1 kit	p. 11
6"	3	p. 14	4	p. 15	1 kit	p. 10	1 kit	p. 11
8"	4	p. 14	4	p. 15	1 kit	p. 10	1 kit	p. 11
12"	6	p. 14	6	p. 15	1 kit	p. 10	1 kit	p. 11
18"	9	p. 14	8	p. 15	1 kit	p. 10	1 kit	p. 11
20"	10	p. 14	9	p. 15	1 kit	p. 10	1 kit	p. 11
24"	12	p. 14	11	p. 15	1 kit	p. 10	1 kit	p. 11

HORIZONTAL TEE

TRAY WIDTH	RADT90		EZT90		Y JUNCTION	
	QTY. REQUIRED	CUT INSTRUT.	QTY. REQUIRED	CUT INSTRUT.	HARDWARE REQUIRED	CUT INSTRUT.
2"	-	-	1 kit	p. 9	-	-
4"	1 kit	p. 8	1 kit	p. 9	p. 12	p. 12
6"	1 kit	p. 8	1 kit	p. 9	p. 12	p. 12
8"	1 kit	p. 8	1 kit	p. 9	p. 12	p. 12
12"	1 kit	p. 8	1 kit	p. 9	p. 12	p. 12
18"	1 kit	p. 8	1 kit	p. 9	p. 12	p. 12
20"	1 kit	p. 8	1 kit	p. 9	p. 12	p. 12
24"	1 kit	p. 8	1 kit	p. 9	p. 12	p. 12

T JUNCTIONS: RAD T 90 KIT

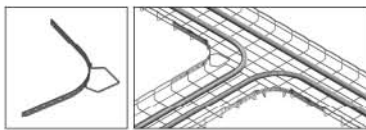

One RAD T 90 KIT will make one T Junction.

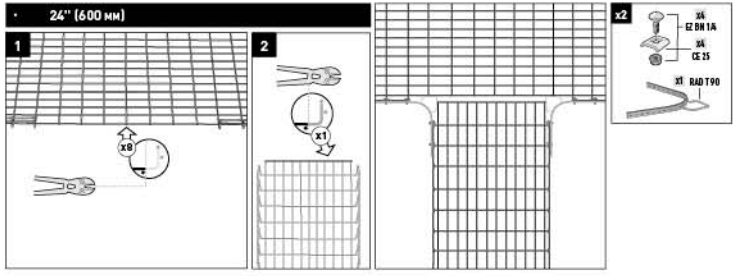
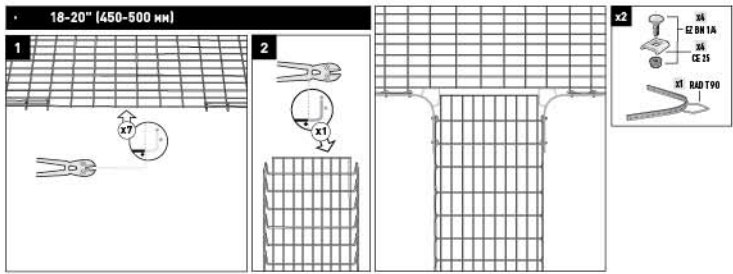
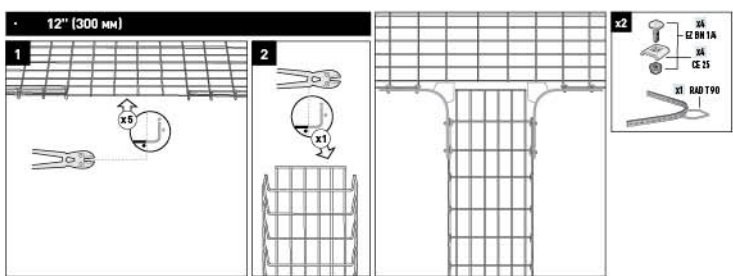
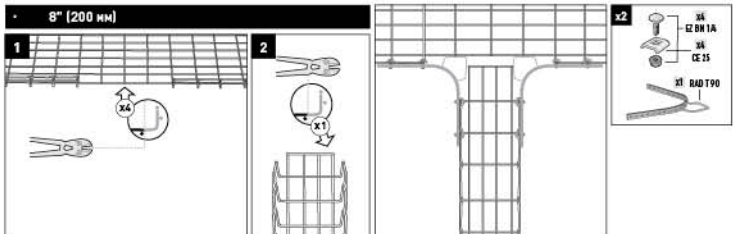
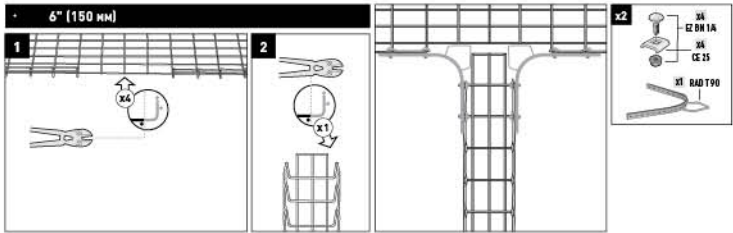
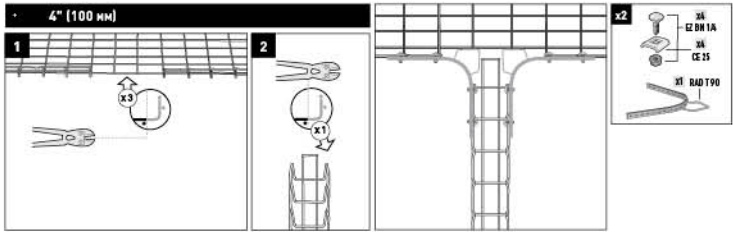

T JUNCTIONS: EZ T 90 KIT

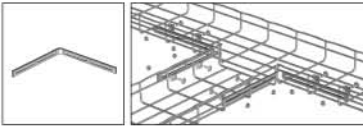

One EZ T 90 KIT will make one T Junction.

2" (50 mm)

x2

- 2x EZ DN 1A
- 2x CE 15
- 1x EZ T 90

4" (100 mm)

x2

- 2x EZ DN 1A
- 2x CE 15
- 1x EZ T 90

6" (150 mm)

x2

- 2x EZ DN 1A
- 2x CE 15
- 1x EZ T 90

8" (200 mm)

x2

- 2x EZ DN 1A
- 2x CE 15
- 1x EZ T 90

12" (300 mm)

x2

- 2x EZ DN 1/4
- 2x CE 25
- 1x EZ T 90

18-20" (450-500 mm)

x2

- 2x EZ DN 1/4
- 2x CE 25
- 1x EZ T 90

24" (600 mm)

x2

- 2x EZ DN 1/4
- 2x CE 25
- 1x EZ T 90

90° BENDS: RAD T 90 KIT



One RAD T 90 KIT will make two 90° Bends.

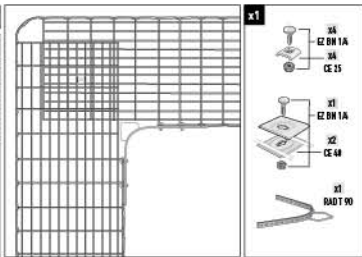
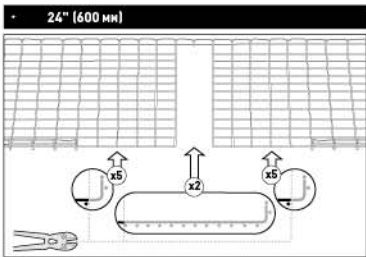
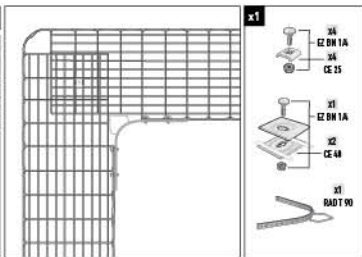
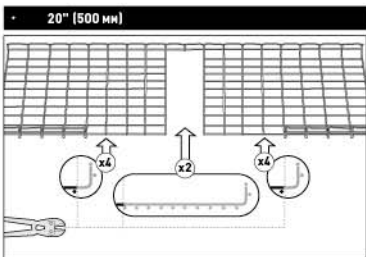
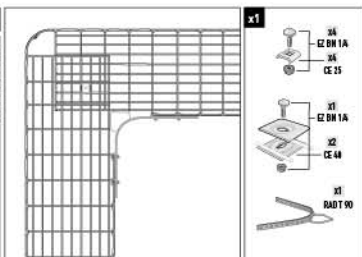
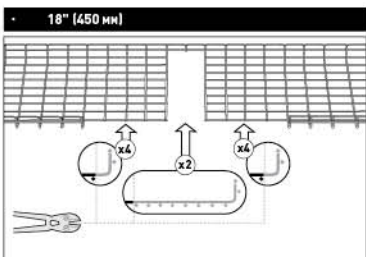
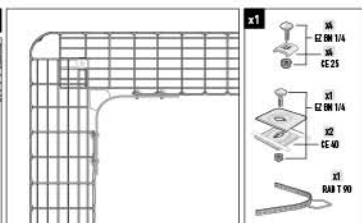
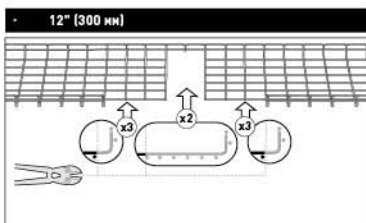
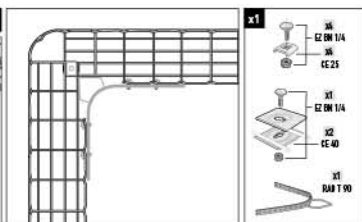
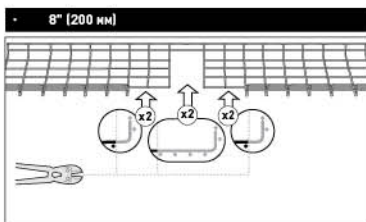
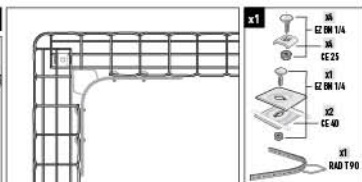
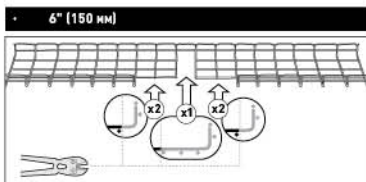
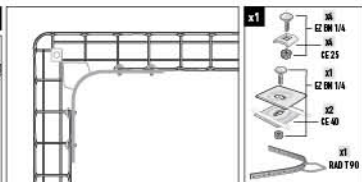
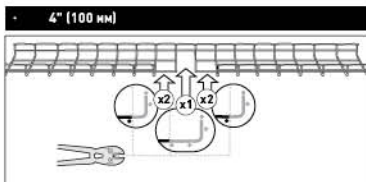

90° BENDS: EZ T 90 KIT

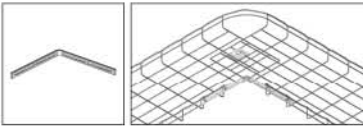

One EZ T 90 KIT will make two 90° Bends. For complete kit description see page 25.

<p>• 2" (50 mm)</p>		<p>x1</p> <ul style="list-style-type: none"> 3/8" EZ DM 1/4 3/8" CE 25 x1 EZ T 90
<p>• 4" (100 mm)</p>		<p>x1</p> <ul style="list-style-type: none"> 3/8" EZ DM 1/4 3/8" CE 25 x1 EZ T 90 x1 EZ DM 1/4 x2 CE 48
<p>• 6" (150 mm)</p>		<p>x1</p> <ul style="list-style-type: none"> 3/8" EZ DM 1/4 3/8" CE 25 x1 EZ T 90 x1 EZ DM 1/4 x2 CE 48
<p>• 8" (200 mm)</p>		<p>x1</p> <ul style="list-style-type: none"> 3/8" EZ DM 1/4 3/8" CE 25 x1 EZ T 90 x1 EZ DM 1/4 x2 CE 48
<p>• 12" (300 mm)</p>		<p>x1</p> <ul style="list-style-type: none"> 3/8" EZ DM 1/4 3/8" CE 25 x1 EZ T 90 x1 EZ DM 1/4 x2 CE 48
<p>• 18" (450 mm)</p>		<p>x1</p> <ul style="list-style-type: none"> 3/8" EZ DM 1/4 3/8" CE 25 x1 EZ T 90 x1 EZ DM 1/4 x2 CE 48
<p>• 20" (500 mm)</p>		<p>x1</p> <ul style="list-style-type: none"> 3/8" EZ DM 1/4 3/8" CE 25 x1 EZ T 90 x1 EZ DM 1/4 x2 CE 48
<p>• 24" (600 mm)</p>		<p>x1</p> <ul style="list-style-type: none"> 3/8" EZ DM 1/4 3/8" CE 25 x1 EZ T 90 x1 EZ DM 1/4 x2 CE 48

Y JUNCTIONS

4" (100 mm)

1

2

x3

See pages 72-73.

6" (150 mm)

1

2

x1

See pages 72-73.

x2

See pages 72-73.

*Use bolt cutters to fabricate this part from EO 275.

8" (200 mm)

1

2

x3

See pages 72-73.

12" - 20" - 24" (300 - 500 - 600 mm)

1

2

x4

See pages 72-73.

18" (450 mm)

1

2

x2

See pages 72-73.

x2

See pages 72-73.

*Use bolt cutters to fabricate this part from EO 275.

90° JUNCTIONS

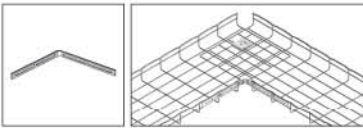

One EZ T 90 KIT will make two 90° Junctions.

<p>• 4" (100 mm)</p>		<p>x1</p> <ul style="list-style-type: none"> • EZ DM 1/4 • CE 25 • EZ T90 • EZ DM 1/4 • CE 48
<p>• 6" (150 mm)</p>		<p>x1</p> <ul style="list-style-type: none"> • EZ DM 1/4 • CE 25 • EZ T90 • EZ DM 1/4 • CE 48
<p>• 8" (200 mm)</p>		<p>x1</p> <ul style="list-style-type: none"> • EZ DM 1/4 • CE 25 • EZ T90 • EZ DM 1/4 • CE 48
<p>• 12" (300 mm)</p>		<p>x1</p> <ul style="list-style-type: none"> • EZ DM 1/4 • CE 25 • EZ T90 • EZ DM 1/4 • CE 48
<p>• 18" (450 mm)</p>		<p>x1</p> <ul style="list-style-type: none"> • EZ DM 1/4 • CE 25 • EZ T90 • EZ DM 1/4 • CE 48
<p>• 20" (500 mm)</p>		<p>x1</p> <ul style="list-style-type: none"> • EZ DM 1/4 • CE 25 • EZ T90 • EZ DM 1/4 • CE 48
<p>• 24" (600 mm)</p>		<p>x1</p> <ul style="list-style-type: none"> • EZ DM 1/4 • CE 25 • EZ T90 • EZ DM 1/4 • CE 48

OTHER THAN 90° JUNCTIONS



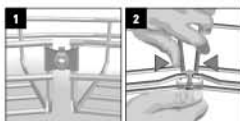
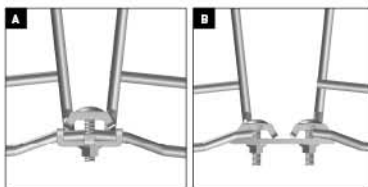

Sweeps can be formed easily on site by cutting some of the side and bottom wires. Use the SWK method to secure desired curve.

Always place bolt heads to inside of tray to prevent frayed wires.

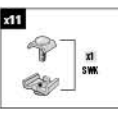
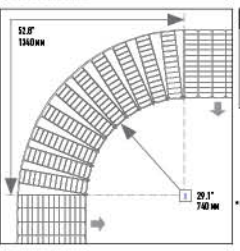
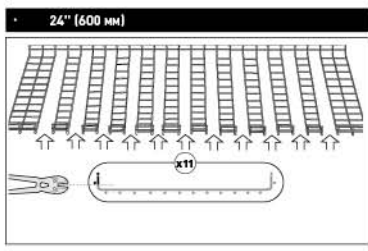
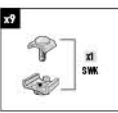
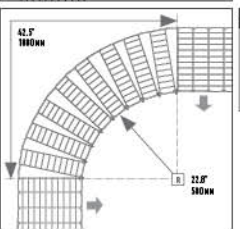
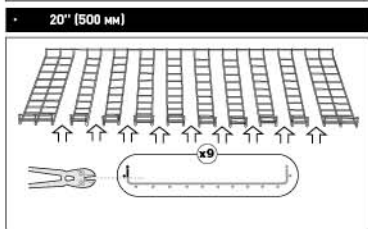
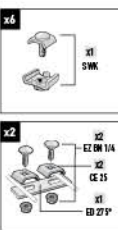
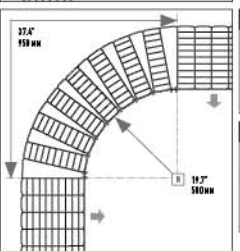
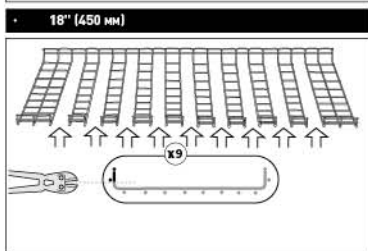
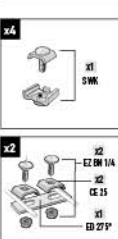
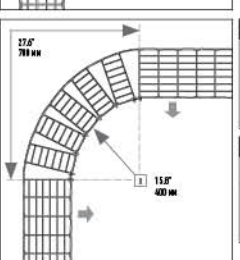
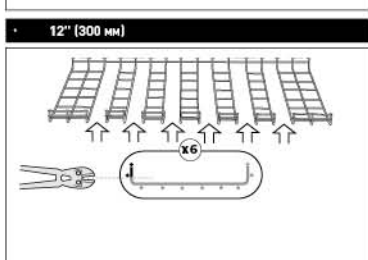
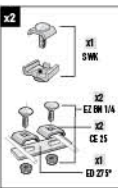
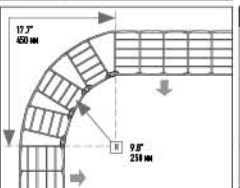
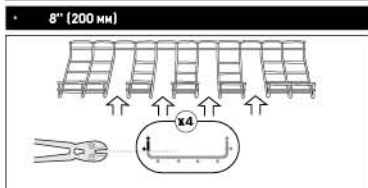
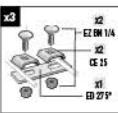
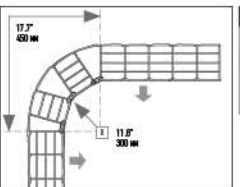
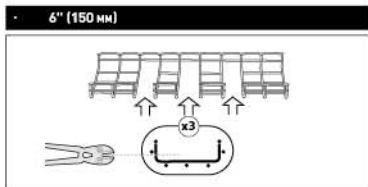
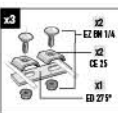
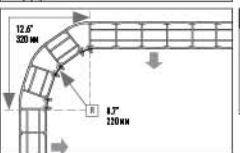
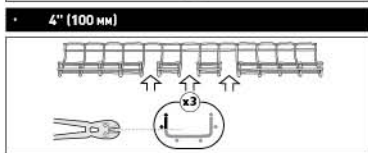
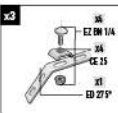
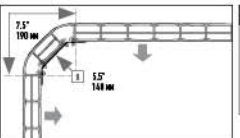
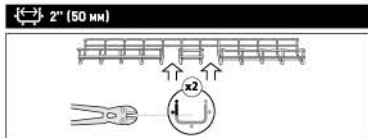

*Use bolt cutters to cut to fit.

SWEEPS: FASLOCK

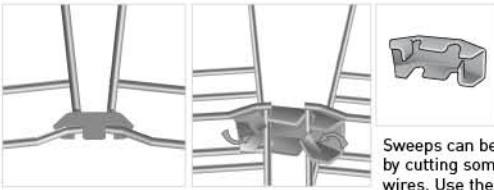

Sweeps can be formed easily on site by cutting some of the side and bottom wires. Use the FASLOCK method to secure desired curve.

<p>4" (100 mm)</p>	<p>FASLOCK S</p>
<p>6" (150 mm)</p>	<p>FASLOCK S</p>
<p>8" (200 mm)</p>	<p>FASLOCK S</p>
<p>12" (300 mm)</p>	<p>FASLOCK S</p>
<p>18" (450 mm)</p>	<p>FASLOCK XL</p>
<p>20" (500 mm)</p>	<p>FASLOCK XL</p>
<p>24" (600 mm)</p>	<p>FASLOCK XL</p>

*Use FASLOCK S for CF54/100, 150, 200, 300, CF105/100, 150, 200. Use FASLOCK XL for all other larger sizes.

REDUCTIONS

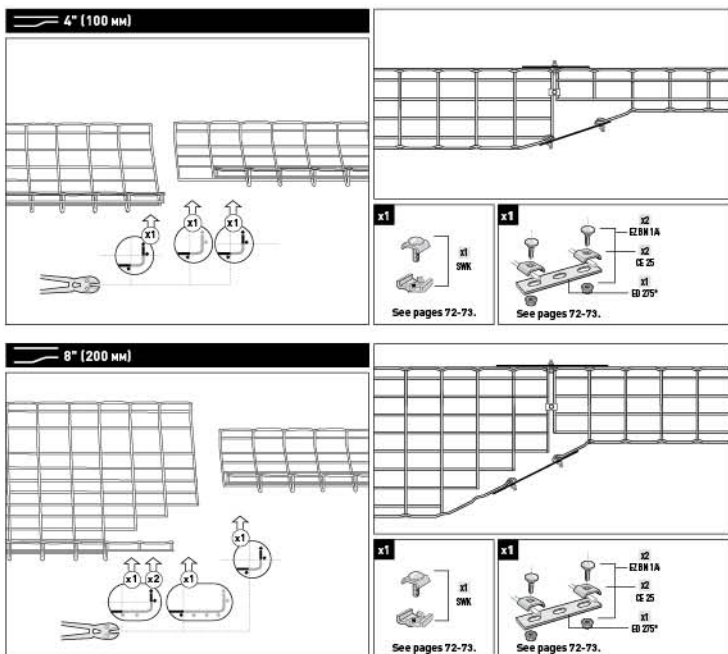

CHANGING LEVELS

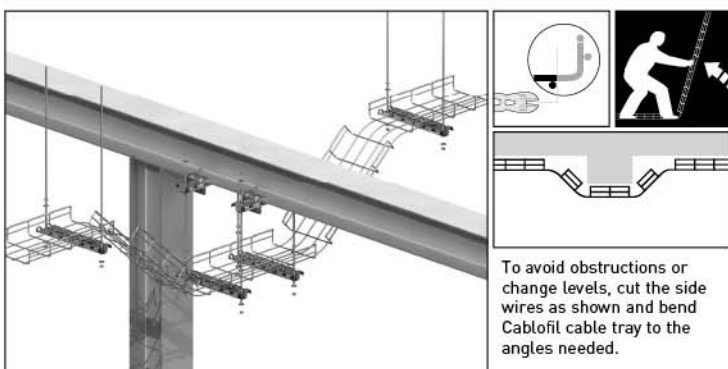

CUTTING AND BENDING

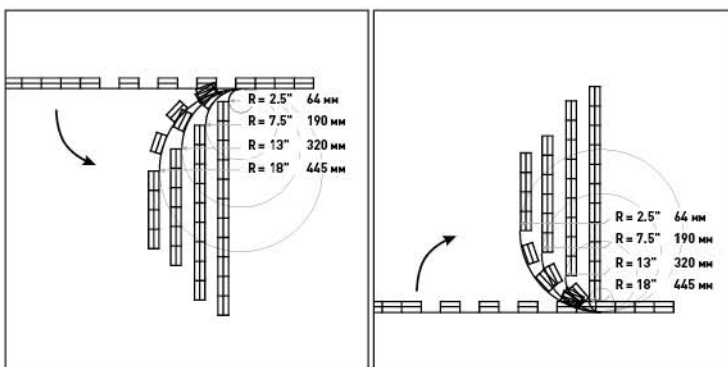

BONDING AND GROUNDING

Per NEC 392, the national electrical code section for cable tray, all cable tray systems must be properly BONDED, per section 259.96. To meet this requirement, Cablofil recommends that ULclassified splices are used to joins sections and that the cable tray be bonded to building steel or the facility grounding system every 50'-60'. By bonding the tray every 50'-60', the tray will maintain a low potential to ground which reduces EMI and provides a continuous path for stray currents. Steel trapeze type hangers clamped securely to building steel usually provide a solid bond. Cablofil standard splices (SWK, EDRN, EZBN, EDT, EZT90, RADT90) are designed to have less than 1 milliohm of resistance between connections and provide bonding between sections. These splices have been tested by UL as part of the cable tray grounding system. Painted Cablofil wire mesh tray requires the outer mask of the conductive surface be removed at each end of the tray prior to installing the (SWK) splice. This (SWK) splice provides a UL Classified Bonding continuity between painted tray sections. All cable tray needs to be electrically continuous per NEC 250.96. Standard Cablofil splices provide continuity per 250.96. Cutting and removal of cable tray sections still allow continuity per 250.96 and only affects the rare use of cable tray as the EGC. Use of cable tray as an EGC is rare since UL requires all multiconductor cables to contain an integral EGC and single conductor cables are only used in a few industrial applications.

LOADING

Cablofil has been tested to UL, CSA, NEMA VE1 and IEC standards. Cablofil wire mesh tray and supports are designed to support any cable load allowed by the NEC when supports are spaced on 8' spans. Only the heaviest cables (750 kcmil multiconductor power or larger) may require shorter spans. For specific loading go to the interactive load table on www.cablofil.com and choose your exact cable for detailed cable capacity and span requirements.

SUPPORT SPACING

Cablofil comes in 118" lengths and straight sections are designed for 6'-8' support spacing; (building joists or purlins are typically on 6'-7' spacing)

Cablofil has developed the following diagrams as a general guideline for supporting Field Fabricated Wire Mesh Tray. These guidelines will provide assistance in estimating and locating supports for the most common wire mesh tray installations. Supports are required as some of the side wires have been cut and the load capacity has been reduced. In actual installation, shallow and narrow trays may not require as many supports just as deep and wide trays may require additional supports. The installer should keep in mind that unique requirements arise in the field and practical solutions are often simple.

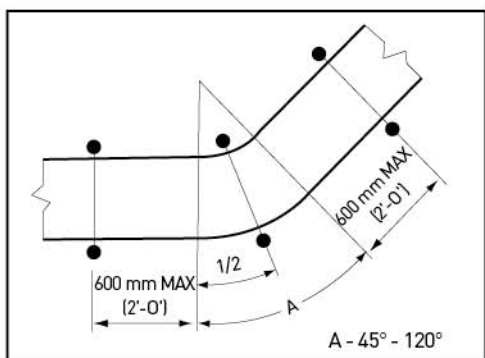

Horizontal Sweep Support

Center support not required on trays less than 12" wide and sweeps less than 45 degrees.

SUPPORT SPACING

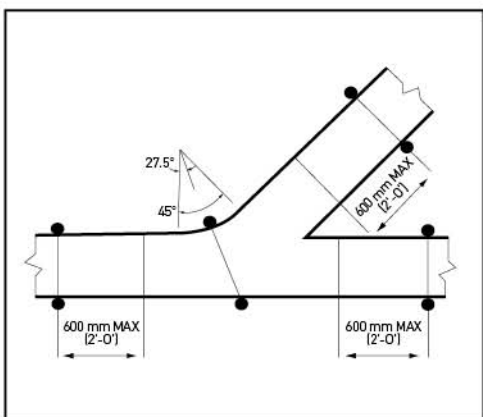

Horizontal Y Support

Center support not required on trays less than 12" wide.

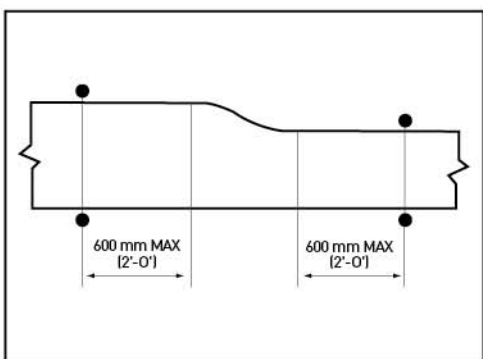

Reduction Support

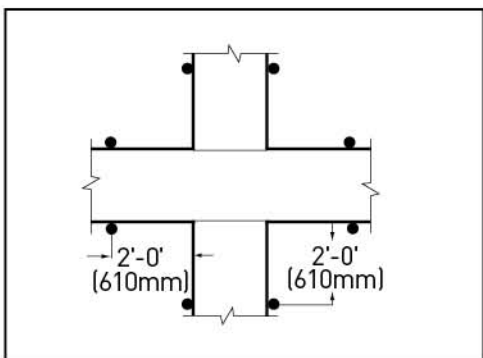

Horizontal Cross Support

On 24' wide items, recommended distance is 1 ft. 6 in. (457mm) from splice connection.

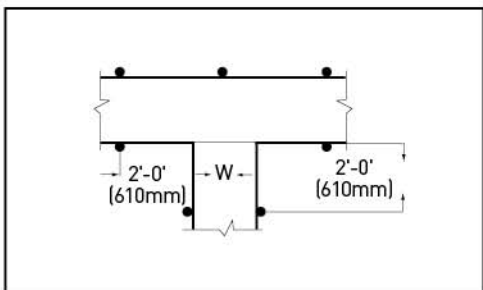

Horizontal Tee Support

Additional support recommended at back of tee (shown) or directly under tee, diagonally positioned, for 4" and 6" deep trays, 18" and wider.

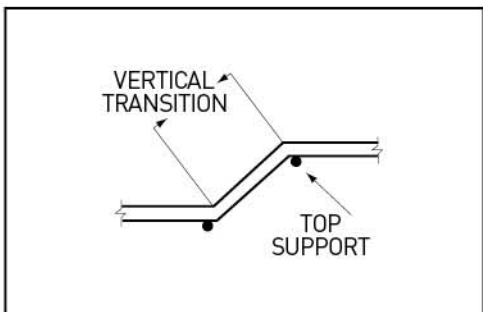

Vertical Transition

Support vertical transition at top support location. Distances of 3 ft. and larger should be supported at each end as illustrated.

TRAY



CF 54

2" DEEP TRAY
2", 4", 6", 8", 12", 18", 20", & 24" WIDE



CF 105

4" DEEP TRAY
4", 6", 8", 12", 18", 20", & 24" WIDE



CF 150

6" DEEP TRAY
12", 18", 20", & 24" WIDE



EasyPack



CFG

G CABLOFIL TRAY



CFG

G MINI



CFL

L CABLOFIL TRAY



TXF35

TELEXRAIL



FCF 54

FASCLIC TRAY

TRAY COVERS



CTXF 35

TELEX RAIL COVER



UC35

TELEX RAIL STANDOFF SUPPORT



CVN

CABLOFIL TRAY COVER



CLIP F02

CABLOFIL COVER CLIP



COT 30/COT 54

DIVIDER STRIP



COT 105/COT 150

DIVIDER STRIP



COT J

DIVIDER COUPLER

SPLICING



EDRN

FAST SPLICE



EDRNT00L

MOUNTING TOOL



PRE-CLICK

SPLICE



EDT

SPLICE PLATE



ED 275

UNIVERSAL SPLICE BAR

SPLICING



SWK
SPLICE WASHER KIT



EZBN 1/4



CE 25 - CE 30
SQUARE SPLICE WASHER



FASLOCK
SPLICE



CE 40
SQUARE SPLICE WASHER



EZT 90 KIT
90° BEND KIT



RAD T 90 KIT
RADIUS TEE 90° KIT

ACCESSORIES



EZBN
1/4"



EZHN
1/4", 3/8", 1/2"



EZFW
1/4", 3/8", 1/2"



THRDL
1/4", 3/8", 1/2"

ACCESSORIES



TRP
THREADED ROD PROTECTOR



EZCN
1/4", 3/8", 1/2"



SWK



CE 25

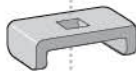

CE 30



CE 40



FASLOCK



ECLI



CA



COUPFIL



CUTYFIL



ED 250/90



ED 275/1100

WALL MOUNTINGS



FAS P
FAS PROFILE



FV
VERTICAL BRACKET



FAS L
BRACKET



FAS C
BRACKET



FAS U
UNIVERSAL BRACKET



EDF
RAIL



CS
STANDARD L BRACKET



CSC
STANDARD C BRACKET



CRP
UNIVERSAL WALL BRACKET

WALL MOUNTINGS



UC 50
CABLE TRAY STANDOFF



CAT 30/41
SNAP-IN WALL
HANGER SUPPORT



C 50
WALL MOUNT ATTACHMENT

CEILING MOUNTINGS



SF 50
CENTER HANGER



SF 100
CENTER HANGER



PAT 30
SUSPENSION SHOE



SAS
SINGLE HANGER
SUSPENSION BRACKET



FAS PCH
CENTER HANGER



FAS P
FAS PROFILE

CEILING MOUNTINGS CONT.



FAS C
BRACKET



AS
TRAPEZE HANGING CLIP



EDF
RAIL



PFREDF
MOUNTING BRACKET



DF
ANGLE MOUNTING BRACKET



ERD 10
BRACE PLATE



PROCS
STANDARD PROFILE



CS
STANDARD L BRACKET



CSC
STANDARD C BRACKET



PS L
PENDANT BRACKET

UNDER FLOOR MOUNTINGS



UFC
UNDER FLOOR SUPPORT CLAMP



UFCN
UNDER FLOOR CLAMP



EDF
RAIL



DF
ANGLE MOUNTING BRACKET



UFS
UNDER FLOOR SUPPORT



UFS 150
UNDER FLOOR SUPPORT STAND



UC 50
CABLE TRAY STANDOFF



UFCF2
WIRE TRAY SECTIONS

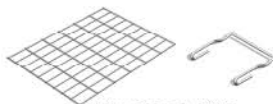

UFS 90° KIT
UFFLAT & UFTXSPRCLP

UFCRSBAR

UFPSTCLP

EDF

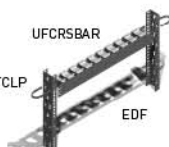

UFSUP KIT
UFS SUPPORT KIT



UFS CANTILEVER BRACKET

OTHER MOUNTINGS



FASCLM
FAS CLAMP



ETC
TRAY BEAM SUPPORT



EZBC
THREADED ROD HANGER



C 50
ELECTRICAL BOX
SUPPORT



SBDA
CONDUIT AND BOX SUPPORT



CM50I
INDUSTRIAL BOX MOUNTING BRACKET



CABLEXIT



HB 2
WALL/FLOOR
TERMINATION BRACKET



DROP OUT
CABLE DROP OUT



CCLMP
CABLE CLAMP



MFM
METALLIC MULTIFX PLATE



CABLE LABEL CLIP



EZVC
VELCRO ROLL



CABLO SNAP
CABLE BUNDLER



EZJB 5/16
J-BOLT



FAS ROLLER



HD FAS ROLLER



GRIPPLE
WIRE CABLE
HANGING SUPPORT



FS 41
FASTRUT CONNECTOR



SZMCKIT
SEISMIC BRACING KIT



SZMCCUTR
CABLE CUTTER



SZMCSWAG
HAND SWAGER



GNDSB
GROUNDING LUG



GNDCL
GROUNDING LUG



FLAMESTOPPER™

CABLOFIL[®]

 **legrand[®]**

www.cablofil.com

Phone 800-658-4641

618-566-3230

Fax 618-566-4978

8319 State Route 4

Mascoutah, IL USA 62258

■ THE WORLD'S MOST SPECIFIED CABLE TRAY.

EZ•331•04•08