



Arlington®

INNOVATIVE PRODUCTS for the Professional, Commercial and Residential Integrator



FOR LOW VOLTAGE • AUDIO • VIDEO • SECURITY • DATACOM SYSTEMS



PRODUCTS FOR THE PROS

Contents

page

page

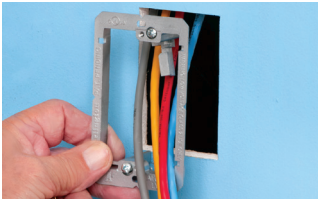

Mounting Brackets

- Existing Work.....3
- Low Profile5
- New Construction.....4, 6



Specialty Mounting Brackets

- Recessed and Adjustable.....7



Power/Low Voltage Combo Boxes

- for New Work and Retrofit5

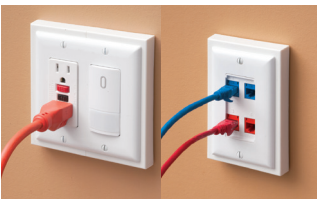

Surface Box Extender

- Adds height and depth to a shallow electrical box.....8



The SCOOP™

- Cable Entry Devices 10
- Reversible Entrance Hood... 11
- Reversible Entrance Plates ... 11

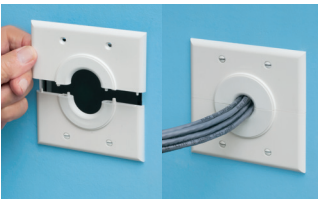

Split Hole Plate

- with bushings to vary size of opening in plate.....9

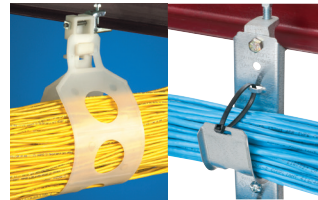

Cable Hangers, Cable Hooks

- Flexible Cable Hanger..... 12
- Plastic and Steel J Hooks ... 12
- The HOOP™ Cable Ring..... 13
- QuickLatch™ Hanger.....28



Wire Management

- Cable Spacers
- Cable Standoffs
- Galvanized Drive Rings
- D Rings
- Wire Bushings 14

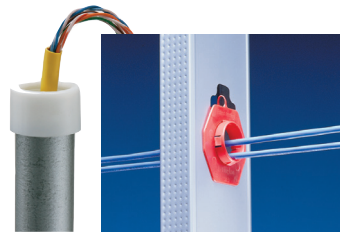

Bushings, Conduit Caps

- Non-metallic for EMT, metal studs 15



Plastic TV BOX™

- Two-, three- and four-gang recessed boxes for new or retrofit projects. Covers too 16



Steel TV BOX™

- Two-, three- and four-gang recessed boxes for projects that use metal cable. Covers too26



Specialty Boxes Security

- Box, cable mounting bar....28
- Enclosure boxes.....29
- 4x4 Fire Alarm boxes.....30
- Security camera mounting kits, boxes 31-33



Floor Boxes

- Power/Low voltage outlets in the same box.....34-35



Arlington®

Cut-in Mounting Brackets for Class 2 Low Voltage Wiring

Non-bendable zinc

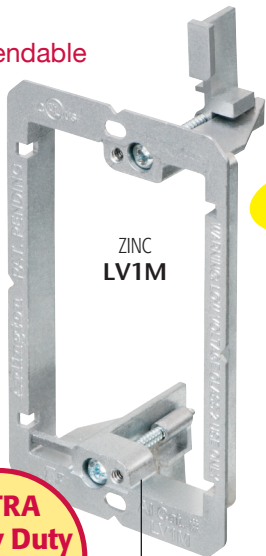

ZINC
LV1M

EXTRA Heavy Duty Commercial Grade

Threaded Holes for easy device installation

Extra rigid Plated steel



Formed thread for 6-32 screws... positive device support!

NEW!

NO Electrical Box Needed

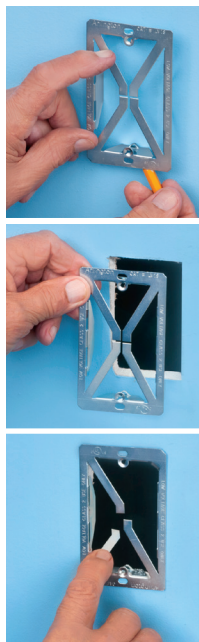

Arlington's Listed cut-in **Low Voltage Mounting Brackets**, for existing walls, are the solution for fast, easy mounting of Class 2 communications, computer and cable TV wiring.

Our new single gang, **ZINC** mounting bracket, **LV1M** offers extra rigidity so it won't bend as easily as plastic. It's ideal for high-end finishes in hospitals, museums and other commercial projects. Plus, it has threaded holes for easy device installation.

- Adjustable – fits 1/4" to 1" wall board



With its unique X-shaped bracket design, the **LV1S PLATED STEEL** mounting bracket, provides excellent stability and secure installation of low voltage devices in 1/4" to 1-1/4" walls - *without an electrical box.*

- Installs with a drywall saw and a screwdriver
- Secure 4-corner wall support



Listed for Canada



CATALOG NUMBER	UPC/DCI/NAED MFG. #018997	DESCRIPTION FOR EXISTING CONSTRUCTION	UNIT PKG	STD PKG
LV1M	12905	Single-gang Extra duty ZINC	10	100
LV1S	99325	Single-gang Plated STEEL	100/box	---

PATENT PENDING



Level

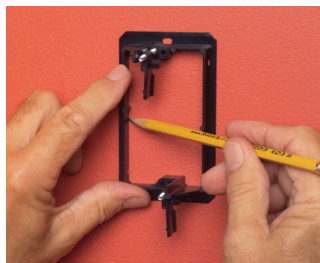

Mounting Wing Design

Centered mounting wing screws hold bracket secure, flush to wall

Recessed Screw Hole Thin Front Lip

and mounting wings seat wall plate flush

Notches

level, center bracket

Flush Wall Plates!

NON-METALLIC LV1 Single-gang Low Voltage Mounting Bracket



Our *non-metallic* mounting brackets have features like specially designed screw holes, centered mounting wing screws, and more, for mounting wall plates flush and delivering a better-looking job.

- Adjustable mounting brackets fit 1/4" to 1" wall thicknesses
- UL/CSA Listed

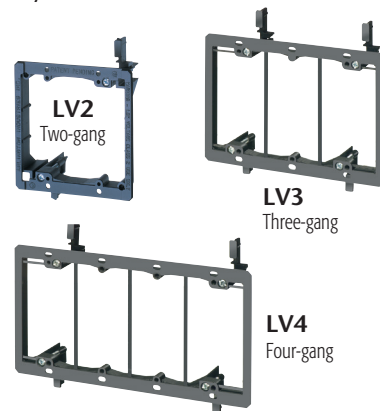

LV2 Two-gang

LV3 Three-gang

LV4 Four-gang

Easy installation... Level the bracket on the wall, then use the bracket as the template for the cutout.

* Trace around the *inside* of the bracket.

CATALOG NUMBER	UPC/DCI/NAED MFG. #018997	DESCRIPTION FOR EXISTING CONSTRUCTION	UNIT PKG	STD PKG
LV1	58175	Single-gang	10	100
LV2	10952	Two-gang	5	50
LV3	09600	Three-gang	5	50
LV4	09601	Four-gang	5	50



Listed for Canada



Arlington®

CABLE MANAGEMENT • New Construction

Nail- or Screw-on Mounting Brackets for Class 2 Low Voltage Wiring

Nail or Screw these **Non-metallic Mounting Brackets** to a wood or steel stud, and you're ready to install low voltage Class 2 wiring!

- Mounts wall plate flush with wall surface
- Built-in loop for tying off cable
- Easy, secure mounting of bracket to studs with nails or screws
- Lower cost than extension rings or mud rings
- Ready to install - nails or screws ship parked-in-place
- UL/CSA Listed



Reinforced corners on three- and four-gang brackets add support against stud

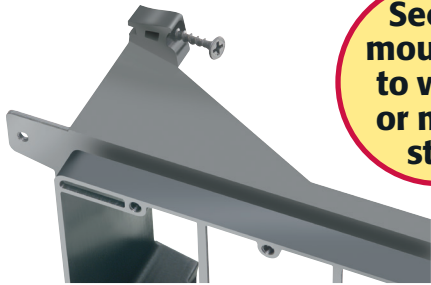

NAIL-ON Mounting Brackets for Class 2 Low Voltage Wiring

CATALOG NUMBER	UPC/DCI/NAED MFG #01 8997	DESCRIPTION FOR NEW CONSTRUCTION	UNIT PKG	STD PKG
LVN1	00261	Single-gang	50	50
LVN2	00275	Two-gang	25	25
LVN3	00277	Three-gang	10	10
LVN4	00278	Four-gang	10	10

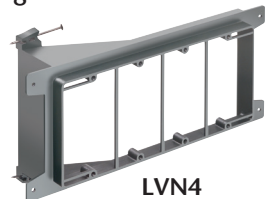

SCREW-ON Mounting Brackets for Class 2 Low Voltage Wiring

CATALOG NUMBER	UPC/DCI/NAED MFG #01 8997	DESCRIPTION FOR NEW CONSTRUCTION	UNIT PKG	STD PKG
LVS1	00262	Single-gang	50	50
LVS2	00280	Two-gang	25	25
LVS3	00282	Three-gang	10	10
LVS4	00283	Four-gang	10	10



Mounting Brackets for Class 2 Low Voltage Wiring

Low Profile mounting brackets for shallow wall cavities



Wing Design

Centered mounting wing screws hold bracket secure, flush to wall

Recessed Screw Hole

Thin Front Lip (and mounting wings) seat wall plate flush

Oval Hole

Levels device

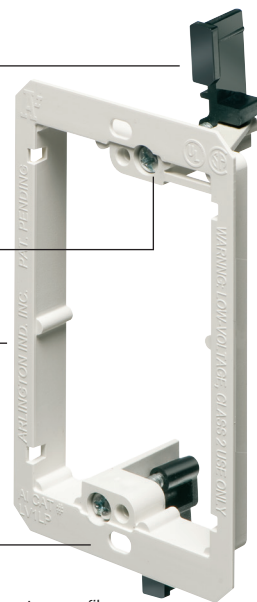

Low profile Single-gang LV1LP

Our cut-in **Low Profile Mounting Brackets** make quick work of installations on drywall installed on furring strips attached to shallow concrete walls.

For existing construction, our low-profile, single- and two-gang non-metallic mounting brackets...

- Fit 1/4 or 5/8 inch drywall or wallboard
- Install faster – cost less than metal
- UL/CSA Listed



CATALOG NUMBER	UPC/DCI/NAED MFG. #018997	DESCRIPTION FOR EXISTING CONSTRUCTION	UNIT PKG	STD PKG
LV1LP	58177	Single-gang/Low Profile	10	100
LV2LP	23102	Two-gang/Low Profile	5	50



Power/Low Voltage Combo Boxes

Sturdy mounting wing screws

LVDR2 for Retrofit



LVD2 for New Work

Pre-drilled screw holes in front flanges

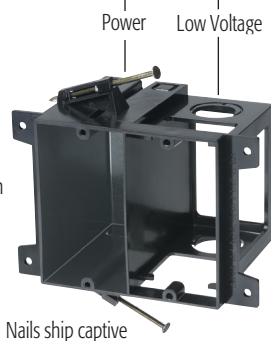

LVDR2 for Retrofit

- Adjusts to fit 1/4" to 1-1/2" thick wallboard
- Mounting wing screws hold box securely in place

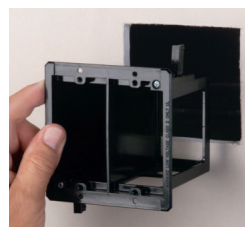

LVD2 for New Work

- Parked-in-place nails ready for use on wood studs
- For metal stud installation, LVD2 has screw holes on front flange (screws not included)



These non-metallic, **Combination Power/Low Voltage Boxes** protect cable from damage and offer the best way to neatly install low voltage installations, such as phone/cable outlets, and fiber optic cable *and* power in the same box.

- Low voltage side includes combo 1/2" and 3/4" knockout for raceway
- Installed NM connector on power side
- Two-hour fire rating
- UL Listed



TWO HOUR FIRE RATING



PATENTED



Arlington®

CATALOG NUMBER	UPC/DCI/NAED MFG. #018997	DESCRIPTION POWER/LOW VOLTAGE BOXES	UNIT PKG	STD PKG
LVDR2	01000	Combination Box • Retrofit	25	25
LVD2	10957	Combination Box • New Work	25	25

CABLE MANAGEMENT • New Work

Non-metallic Mounting Brackets for Class 2 Low Voltage Wiring

- Non-metallic mounting brackets with convenient wire tie-off at top of bracket for new work
- Sturdy tabs provide extra-secure vertical or horizontal mounting of Class 2, low voltage wiring
- Costs less than metal extension rings



Use 3/4" EMT or 1" fitting with versatile LVH1K



CATALOG NUMBER	UPC/DCI/NAED MFG. #018997	DESCRIPTION FOR NEW CONSTRUCTION	UNIT PKG	STD PKG
LVH1K	10984	Single-gang • 3/4" and 1" knockouts	50	50
LVH1	10979	Single-gang	50	50

PATENTED

- Non-metallic single- and two-gang mounting brackets that facilitate the use of 3/4" raceway
- For communications, cable TV, and computer wiring
- Works with 1/2" or 5/8" drywall
- UL/CSA Listed



PATENTED

CATALOG NUMBER	UPC/DCI/NAED MFG. #018997	DESCRIPTION FOR NEW CONSTRUCTION	UNIT PKG	STD PKG
LVMB1	14364	Single-gang	10	100
LVMB2	14365	Two-gang	5	50



Arlington®

Recessed and Adjustable Low Voltage Mounting Brackets

Recessed Connections don't extend past wall

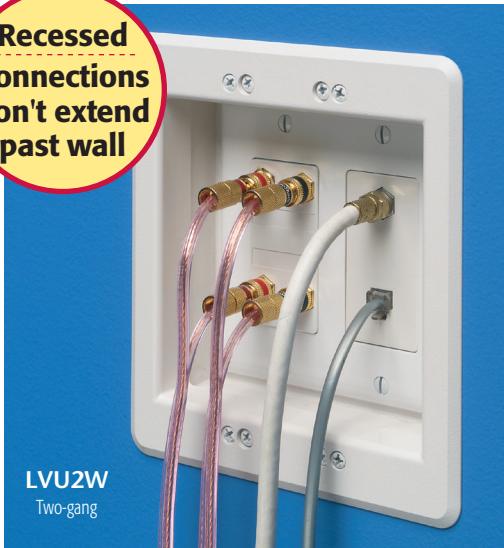

LVU2W
Two-gang



1 Old work Attach trim plate to bracket. Insert assembly into opening. Tighten mounting wing screws to hold bracket in wall.

2 New work Mount bracket on stud using tabs to position it properly

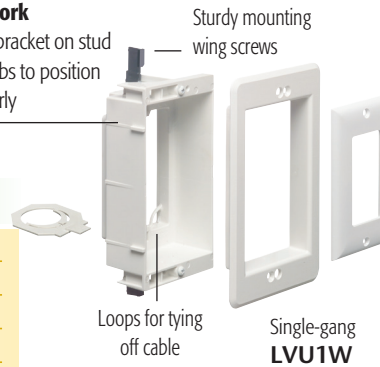

CATALOG NUMBER	UPC/DCI/NAED MFG. #018997	DESCRIPTION FOR OLD OR NEW WORK	UNIT PKG	STD PKG
LVU1W	00285	Single-gang	1	4
LVU2W	20011	Two-gang	1	4
LVU3W	20012	Three-gang	1	1
LVU4W	20013	Four-gang	1	1

These non-metallic **Recessed Low Profile Mounting Brackets** offer quick and easy installation in old or new work.

And they're recessed so connectors don't extend past the wall surface.

In old work mounting wing screws hold the bracket securely against the wall when tightened. In new work the mounting bracket mounts to a stud.

- Adjustable to fit 1/4 to 1-1/2 inch wall thicknesses
- Recessed bracket includes loops for cable tie-off, two attachable knockouts, one device plate, one trim plate and four screws
- Paintable
- UL/CSA Listed



PATENTED



Adjusts to final wall thickness up to 1-1/2"



Single-gang LVA1

CATALOG NUMBER	UPC/DCI/NAED MFG. #018997	DESCRIPTION FOR NEW CONSTRUCTION	UNIT PKG	STD PKG
LVA1	09750	Single-gang • Adjustable depth	25	25
LVA2	09751	Two-gang • Adjustable depth	10	10

Two-gang LVA2

Non-metallic **Adjustable Mounting Brackets** for Class 2 low voltage wiring installations in new construction.

They're easy to install and look great!

- Set for a 1/2" thick wall finish, they adjust up to 1-1/2" for use when the wall thickness is unknown
- Support tabs deliver secure mounting of the bracket to wood or steel studs in new construction
- Always accessible depth adjustment screw allows for fitting the bracket depth to the final wall finish thickness - *before or after the wall is done*

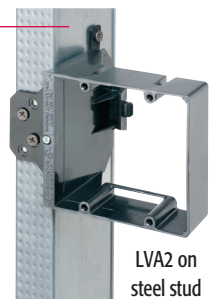

PATENTED



Arlington®

CABLE MANAGEMENT • Retrofit

Add Height, Depth to a Shallow Box with this Box Extender

Add height *and* depth to a shallow electrical box – the easy way – with Arlington’s **Listed BES series** non-metallic Box Extenders.

Fast and convenient, and perfect for installing a motion detector or low voltage device.– or an outlet in the two-gang BES2. Attaching a BES box extender adds 5/8” of height to an installed shallow box *without* removing the box.

- **Enlarges box volume**
BES1 adds 5.3 cu. inches
 Two-piece **BES2 adds 10.5 cu. inches**
- Both accommodate standard or mid-size cover plates

Need more gangs?

Add a coupler pair.
 Each set adds one gang,
 and an additional 3.5 cu. inches of volume.

NEW!

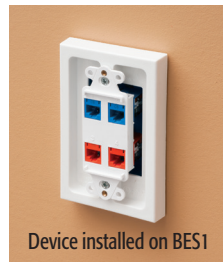
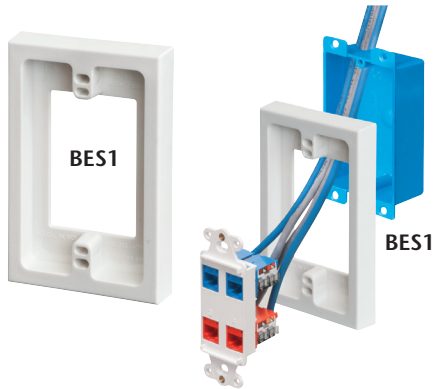

CatALOG NUMBER	UPC/DCI/NAED MFG. #018997	DESCRIPTION SHALLOW BOX EXTENDER	UNIT PKG	STD PKG
BES1	48976	Single-gang	1	10
BES2	48977	Two-gang (two piece)	1	10
BES2C	48979	One gang coupler set. Adds one gang to BES2.	1	10



PATENTED

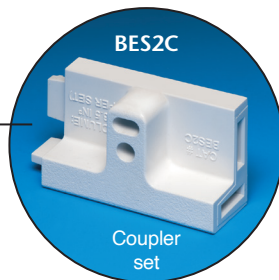

CABLE MANAGEMENT

Versatile, Non-metallic Split Hole Plates

Multiple Grommet Sizes for Each Plate



Single-gang CESP1
.312" bushing installed



Two-gang CESP2
1.250" bushing installed

Arlington's non-metallic **Split Hole Plates** provide a simple and effective way to accommodate pre-connectorized low voltage cable(s) of varying size and quantity or pre-existing low voltage cables.

Multiple split grommets are provided with our single- and two-gang wall plates for increased versatility in effectively sizing and covering the hole/opening.



with 1" bushing



with .500" bushing



No bushing, 2" opening



with .750" bushing

Use as shipped, or with one of the supplied bushings to alter the size of the opening.

Single-gang CESP1 has a 1-1/2" opening, and comes with (3) bushings for .312", .500" and 1" openings.

Two-gang CESP2 with 2" opening, provides (2) bushings for .750" and 1.250" openings.

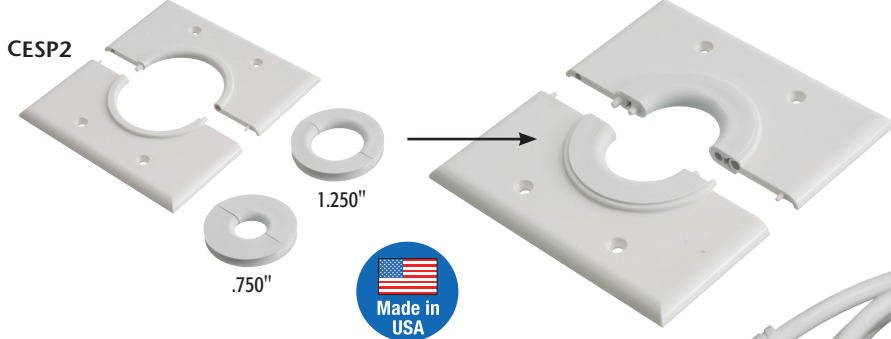

CatALOG NUMBER	UPC/DCI/NAED MFG. #018997	DESCRIPTION NON-METALLIC SPLIT HOLE PLATE	UNIT PKG	STD PKG
CESP1	99339	Single-gang plate, with (3) bushings".312", .500", 1"	1	10
CESP2	99340	Two-gang plate, with (2) bushings: .750", 1.250"	1	10

NEW!



PATENT PENDING



Arlington®

THE SCOOP™ Cable Entry Devices

The attractive way to organize and protect cable

Get a great-looking installation with Arlington's **Cable Entry Devices**.

They organize and protect low voltage cable against damage and abrasion.

Offered with a slotted or brush style cover, CED130 and CED135 hold low voltage cable neatly in place while allowing even the largest HDMI connectors to pass through.

CED13 and CED130 have mounting holes for attaching a decorator-style wall plate to the low voltage side of a box...adding support to the installation.

**The
Neat
Way
to
Organize
Cable**



PATENTED

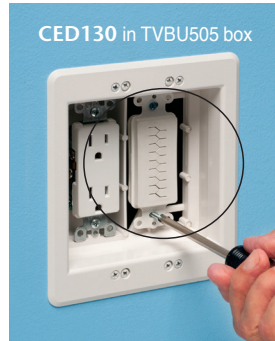

CED13



CED130

CATALOG NUMBER	UPC/DCI/NAED MFG #01 8997	DESCRIPTION CABLE ENTRY DEVICES	UNIT PKG	STD PKG
CED13	13000	Device	1	25
CED130	13015	Device w/ slotted cover	1	25
CED130WP	11020	Device (slotted) w/ wall plate	1	10
CED135	04096	Device w/ brush style cover	1	25
CED135WP	11021	Device (brush) w/ wall plate	1	10



CED135

All include (2) #6 screws



Arlington®



Listed for
Canada

CABLE MANAGEMENT

The LOOP™ Flexible, Non-metallic Cable Hangers

Flexible and non-metallic, **The LOOP™** provides sturdy, reliable support of CAT 6(e) or 7 – or fiber optic cable without sagging, bending or damaging the cable! The LOOP holds a 2" to 5" diameter bundle of cable.

- Fast and easy to use – less costly than cable trays
- Single or multiple LOOP hangers mount in a variety of ways and rotate to any angle
- UL/CSA Listed for environmental air handling spaces per NEC 300-22(c) code requirements
- Available with or without UV rating
- Sizes/Cable Holding Capacity
 - 2" TL20 holds a 2" bundle
 - 2.5" TL25 holds a 2.5" bundle
 - 5" TL50 holds a 5" bundle of communications cable



**Listed for
Environmental
Air Handling
Spaces**



Arlington
BC25 beam clamp

TL50
holds 5" cable
bundle

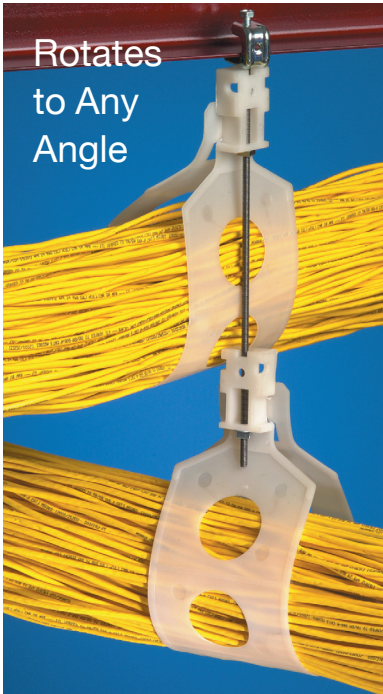

Rotates
to Any
Angle

CATALOG NUMBER	UPC/DCI/NAED MFG #01 8997	LOOP SIZE	# CAT 6(e) CABLES	UNIT PKG	STD PKG	LENGTH	WIDTH	LOAD RATING
TL20	38084	2"	30	100	100	11.375	.652	25
TL25	38085	2-1/2"	40	50	50	12.250	1.500	25
TL50	38086	5"	140	25	25	22.500	5.000	75
TL20P*	38087	2"	30	100	100	11.375	.652	25
TL25P*	38088	2-1/2"	40	50	50	12.250	1.500	25
TL50P*	38089	5"	140	25	25	22.500	5.000	75

* 'P' indicates UV Rated.



Arlington®



Listed for
Canada

High Speed Cable Ring for Communications Cable

The HOOP™ High Speed Cable Ring

Versatile Horizontal or Vertical mounting.
Available with or without 1/4-20 screw.

Mounts ON a beam clamp, wood beam or threaded rod, or UNDER a beam clamp. Use with threaded rod too.

- Complies with TIA/EIA standards

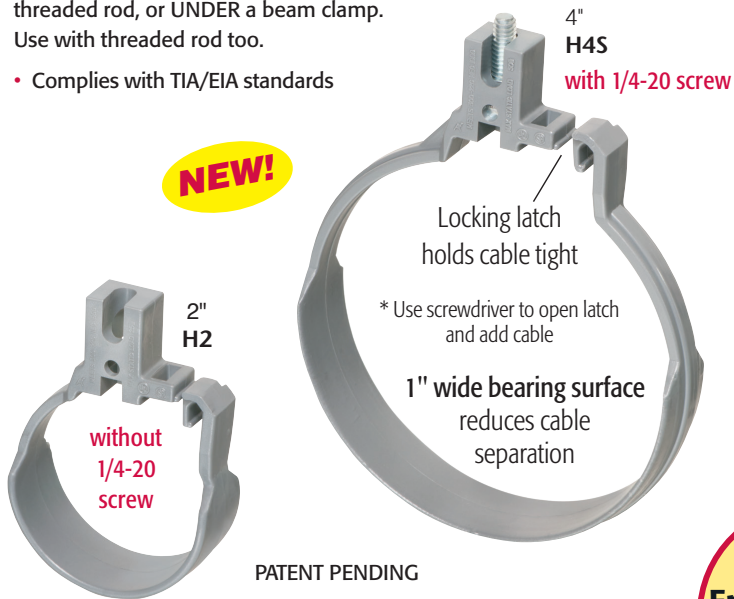

Listed for Environmental Air Handling Spaces



CATALOG NUMBER	UPC/DCI/NAED MFG #01 8997	THE HOOP SIZE	LOAD RATING	UNIT PKG	STD PKG
H2	50184	2"	25	100	100
H2S	50185	2" with 1/4-20 screw	25	100	100
H4	50186	4"	50	50	50
H4S	50187	4" with 1/4-20 screw	50	50	50



Arlington®

TV BOX™

PLASTIC RECESSED POWER & LOW VOLTAGE COMBO BOXES

Arlington's **PLASTIC** recessed combination power and low voltage boxes – TV BOX™, TV BRIDGE™ KITS and Indoor IN BOX® – offer the secure, easy way to mount hi-def, LED TVs flush against a wall.



The job looks great because plugs and connections stay *inside* these boxes without extending past the wall.

Available in special sizes, as well as two-, three- and four-gang for new work or retrofit. Each offers power and/or low voltage in

one or more of the other openings. There's a box to fit nearly any application!

- Non-metallic box with paintable white trim plate
- In retrofit, tightening mounting wing screws hold box in wall – In new construction, box screw-mounts to stud
- Easy to cover when not in use with optional covers (sold separately)
- cULus Listed



PLASTIC TV Boxes – by size



5x8, Low Profile

TVL508 17



Two-Gang

TVBU505 power/low voltage for interior use 20
Box Kits and Covers 20
DBV series power/low voltage for flat exterior walls 25



8 X 10

TVBU810 18
Cover for TVBU810 18



Three-Gang

DVFR3W 19
TVB713 22
TVBU507 power/low voltage 20
Cover 20



TV Bridge™ Kits

TVBR2505K 23
Two power/low voltage combo boxes
TVL2508K
Low profile kit for shallow walls 24

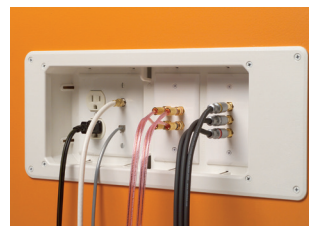

Four-Gang

DVFR4W 19
TVB613 21
Cover 21



Single-Gang

DVFR1W 19
TVB712 22



STEEL TV Boxes

Two-, three- and four-gang styles for use in new or retrofit projects that use metal cable.

See pages 26-27



PLASTIC Low Profile 5x8 TV Box for Installations on Shallow Walls

Arlington's **Low Profile 5" x 8" TV BOX™** is ideal for TV installations on 1/2" or 5/8" drywall with wall cavity depths as shallow as 3/4" (or deeper). Applications in new work or retrofit include:

- Furring strips on concrete block walls
- 2x2, 2x3 and 2x4 or larger studs

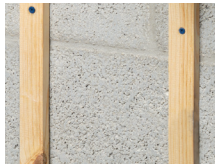

The low profile TVL508 box can also solve the problem of plumbing or other obstructions running inside the wall cavity.

It has lots of room inside for multiple cables and brackets for tying them off – keeping the installation neat and organized.

- Plugs stay inside box; TV mounts closer to the wall
- Mounting wing screws hold box securely in the wall
- Includes cULus Listed decorator-style receptacle
- cULus Listed

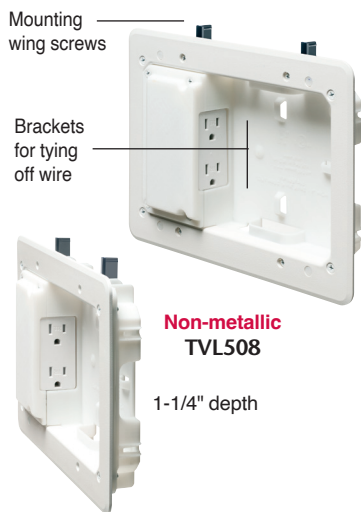

CATALOG NUMBER	UPC/DEI/NAED MFG. #018997	DESCRIPTION	UNIT PKG	STD PKG
TVL508	52307	LOW PROFILE PLASTIC TV BOX™ 5" x 8" power/low voltage box	1	4
TVL508GC	09753	5" x 8" power/low voltage box w ground clip for Canada	1	4

with STEEL BACK BOX
for use with MC, AC, flexible metal conduit

TVL508S	15240	5" x 8" power/low voltage box	1	4
----------------	-------	-------------------------------	---	---

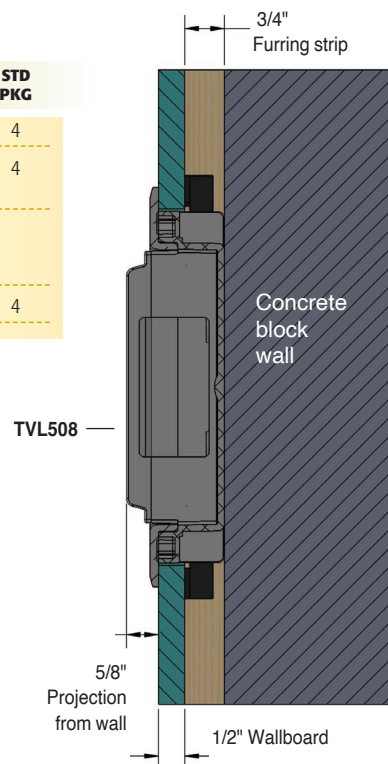
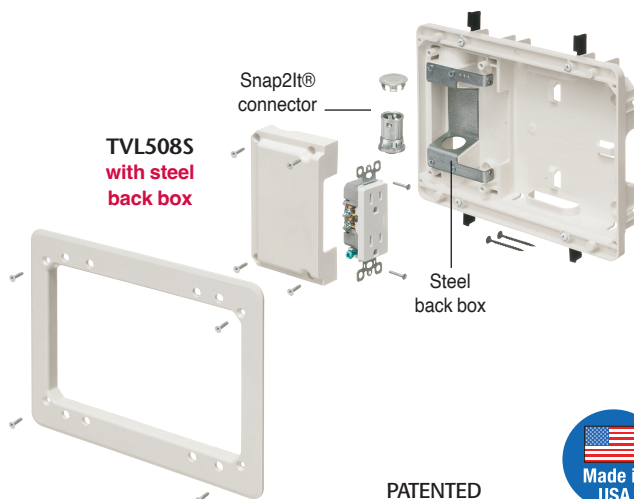

PATENTED



Arlington®

PLASTIC 8x10 TV BOX™ • Horizontal or Vertical Mounting



TVBU810
8x10 TV BOX™

Arlington's 8x10 TV BOX™ delivers the ultimate in versatility for installing wall-mounted TVs in new or retrofit projects. There's more room in the box for wires. And, you can install it horizontally or vertically to ensure proper positioning of low voltage connections behind the TV.

TVBU810 is ideal for home theater systems where multiple connections are needed for sound systems, satellite TV, cable TV, DVRs, and more.

- Accepts standard-style plates with receptacles and decorator-style devices with plates - and Arlington's SCOOP™ series entrance plates and hoods
- In retrofit, mounting wing screws hold box secure against wall – Box mounts to stud in new construction
- 1-1/2" knockout for ENT or other low voltage wiring
- cULus Listed

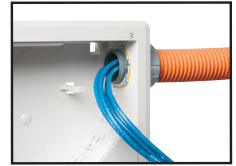

New Work



Retrofit

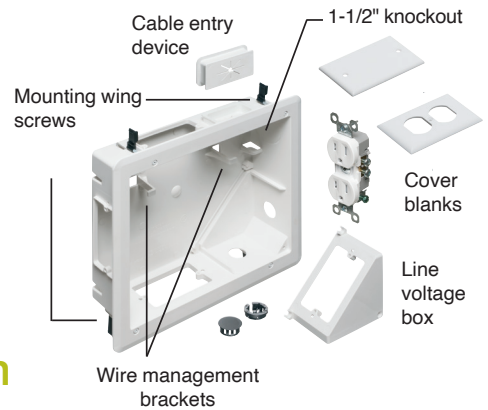

Lots of space inside for multiple low voltage connections...Brackets for a neater installation

CATALOG NUMBER	UPC/DCI/NAED MFG. #018997	DESCRIPTION 8X10 PLASTIC TV BOX™	UNIT PKG	STD PKG
TVBU810	09758	8"x10" power/low voltage box	1	1
TVBU810GC	13631	8"x10" power/low voltage box with ground clip (for Canada)	1	1
TVB810C	24193	Plastic cover for TVBU810	1	10

Supplied with cover blanks, wall plate, a SCOOP cable entry device (CED130) and cable connectors for unused openings.

for STEEL box See page 27



PATENTED

PLASTIC IN BOX® • Fire-rated Recessed Electrical Boxes, Covers

Arlington's **Recessed Indoor IN BOX®** for new work or retrofit, allows TVs and furniture to be placed flush against the wall.

For power or low voltage, indoor IN BOX mounts securely to a stud in new construction or to drywall in retrofit.

The box is recessed so plugs don't extend past the wall, like they do in a regular box. You can mount TVs flush or push furniture closer to the wall.

- Positioning tabs for 1/2" wall thickness assure accurate placement on stud
- Mounting wings hold box secure in wall when screws are tightened
- Textured, paintable trim plate covers edges of cut drywall
- Horizontal or vertical mounting
- Multiple styles for new construction or retrofit
- Covers available for two- and three-gang styles

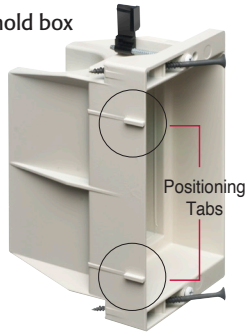

DVFR1W
Single-gang IN BOX



**TWO HOUR
FIRE RATING**



DVFR2W
Two-gang IN BOX



CATALOG NUMBER	UPC/DCI/NAED MFG. #018997	DESCRIPTION INDOOR IN BOX® & COVERS	COLOR	UNIT PKG	STD PKG
DVFR1W	14330	Single-gang • 21.0 cu in	White	1	4
DVFR2W	14331	Two-gang • 34.0 cu in	White	1	4
DVFR3W	14340	Three-gang • 49.3 cu in	White	1	1
DVFR4W	14342	Four-gang • 64.5 cu in	White	1	1
DVFR3C	10570	Non-metallic Blank Cover for Three-gang Box	White	10	10
DVFR2C	10571	Non-metallic Blank Cover for Two-gang Box	White	10	10

Add suffix "GC" to catalog number when ordering box with ground clip for use in Canada (i.e. DVFR1WGC).

PATENTED



PLASTIC Power/Low Voltage Multiple Gang TV BOX™

Two-gang combo box for NEW or RETROFIT

TVBU505



Three-gang for NEW or RETROFIT

TVBU507



Arlington's Recessed **Two- and Three-gang TV BOX™** for new work or retrofit allows mounting of TVs, and other system components flush against the wall. These combo boxes offer power and low voltage for Class 2 wiring of satellite or cable TV, speakers, etc in the same box.

In retrofit, mounting wings hold the box firmly in place. There's no wobble once it's installed. In new construction, box mounts to stud for secure support.



Positioning tabs for new work

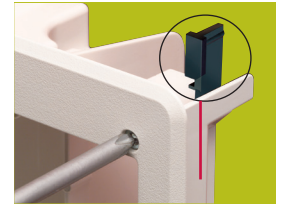

Mounting wings for existing walls

New Work



1 Attach box to stud. Use tabs, set for 1/2" or 5/8" drywall, for proper positioning of box depth.



2 Attach paintable trim plate with screws provided.



OPTION for new work: For added box stability tighten mounting wing screws to secure box in wall.

For installation in Existing Wall

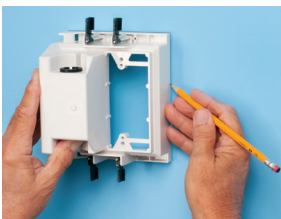

1 Determine location. Use box, without trim plate, as template for hole.



2 Cut drywall. Attach trim plate. Install assembly in opening.



3 Mounting wing screws secure box in the wall.

Secure installation. Good looks.

A great finish. *Plugs stay inside – don't protrude past the wall*

- For walls up to 1-1/2" thick
- Covers available for two- and three-gang styles

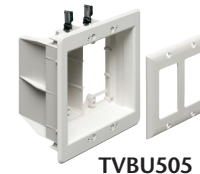

TVBU505



TVBU507



Listed for Canada

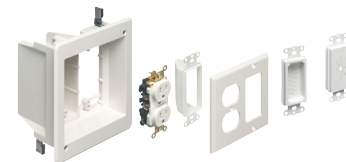

TVBR505K includes box, tamper-resistant duplex receptacle SCOOP™ entrance hood, cable entry device, duplex decorator-style wall plate

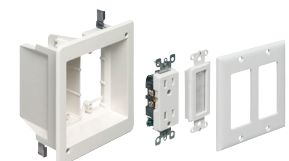

TVBU505K

includes box, tamper-resistant duplex receptacle, brush-style cable entry device, two-gang decorator-style wall plate



Arlington®

PATENTED

CATALOG NUMBER	UPC/DCI/NAED MFG. #018997	DESCRIPTION NON-METALLIC TV BOX™ & COVERS	UNIT PKG	STD PKG
TVBU505	09636	Two-gang, power/low voltage	1	4
DVFR3	14337	White Blank Cover for TVBU505	10	10
TVBR505K	09670	Two-gang, power/low voltage kit for retrofit	1	4
TVBU505K	09682	Two-gang, power/low voltage kit for new work or retrofit	1	4
TVBU507	09661	Three-gang, One power/two low voltage	1	4
DVFR3	10570	White Blank Cover for TVBU507	10	10

Add suffix "GC" to catalog number when ordering box with ground clip for use in Canada (i.e. TVBU505GC)

PLASTIC Four-gang Power/Low Voltage Recessed TV BOX™

Arlington's **Recessed, Four-gang TV BOX™** for new or retrofit mounts TVs flush against a wall. The double-gang design allows the installation of two duplex receptacles or low voltage devices. Or, use the supplied box separator to install one low voltage device and one duplex receptacle. TV BOX also has two additional built-in mounts for low voltage, data/media connections; speakers, satellite TV.

Looks great. Saves space.
Recessed – plugs don't protrude



- 13" wide, 26.2 cu in non-metallic box
- Mounts between 16" o.c. studs for secure horizontal or vertical installation
- Textured, paintable trim plate covers edges of cut drywall
- cULus Listed



Voltage Separator

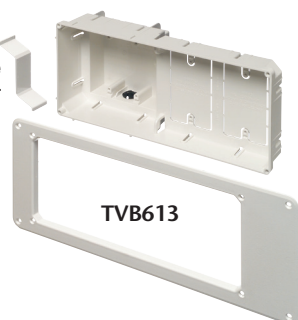

CATALOG NUMBER	UPC/DCI/NAED MFG. #018997	DESCRIPTION	COVER COLOR	UNIT PKG	STD PKG
TVB613	09630	FOUR-GANG NON-METALLIC TV BOX™ Four-gang power/low voltage box • 26.2 cu in	White	1	1
TVB613C	09631	Blank cover fits TVB613	White	5	5

Includes recessed TV BOX w/ trim plate, low voltage separator, NM cable connector and installation screws
 Add suffix "GC" to catalog number when ordering box with ground clip for use in Canada (i.e. TVB613GC).



PATENTED



for STEEL box See page 27



Paintable Box Covers for Two- and Three-gang IN BOX® or TV BOX™

Arlington's Non-metallic paintable **Box Covers** keep unused non-metallic boxes clean until you're ready to complete the installation. Boxes with an Arlington box cover look better at eye-level and blend into the wall, especially when painted.

- Fits two- or three-gang indoor IN BOX (page 19) and two- or three-gang TV BOX (page 20)
- Easy press-on installation



CATALOG NUMBER	UPC/DCI/NAED MFG. #018997	DESCRIPTION	COVER COLOR	UNIT PKG	STD PKG
DVFR3C	14337	NON-METALLIC PAINTABLE BLANK COVER Non-metallic • Paintable Blank Cover for two-gang box	White	10	10
DVFR3	10570	Non-metallic • Paintable Blank Cover for three-gang box	White	10	10

PATENTED



Arlington®

PLASTIC Multiple Gang Combo TV BOX™ with Angled Openings

Designed for new or retrofit, these **TV boxes with Angled Outlet Boxes** take convenience to a new level.

The versatile TVB712 offers power and and/or low voltage. The larger TVB713 has power and low voltage openings for video, audio and other datacom connections. Two angled outlet boxes keep plugs behind the wall surface, and allow the use of close-clearance TV mounting hardware. *You really CAN mount a TV flush against a wall.*

- Non-metallic, paintable trim plate
- Optional cover for unused 13" box
- Available with ground clip for use in Canada

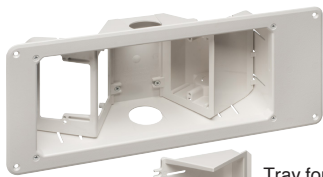

TVB713 Tray for converter



TVB613C Blank Cover



New Work Installation



Tabs for proper positioning on stud

1 Attach box to stud through slotted holes with a minimum of (2) #6 x 1-5/8" wood screws.



2 Pull wire. After installing the wall, install enclosure assembly and devices. Make connections.

Retrofit Installation



1 Use box without trim plate, as template for opening. Cut hole next to stud. Pull wires. Insert box into hole.



2 Assemble trim plate. *Retrofit must also use a minimum of (2) #6 x 1-5/8" wood screws in adjacent stud. Install enclosure assembly and devices.



3 Make connections.



TVB712



TVB712



PATENTED

CATALOG NUMBER	UPC/DCI/NAED MFG. #018997	DESCRIPTION RECESSED • ANGLED OPENINGS	UNIT/STD PKG
TVB712	09712	(1 each) Power and/or low voltage	1
TVB713	09713	(1) Power and multiple low voltage openings w/ interchangeable tray	1
TVB613C	09631	Non-metallic, blank cover for TVB713	5

Add suffix "GC" to catalog number when ordering box with ground clip for use in Canada (i.e. TVB713GC).



PLASTIC TV BRIDGE™ Complete Box Kit for TV Installations

Arlington's **TVBR2505K TV Bridge™ Kit** includes TWO recessed power/low voltage combo boxes and all the connections you need *except the NM cable* to install a TV and additional components.

There's no need to run cable from a panel box or to cut holes in your framing members.

Just cut two holes in the wall and access power from an existing, nearby source.

- Secure installation. Good looks. A great finish.
- All wires stay hidden behind the wall – no messy wires running from TV to components
- Plugs stay inside the electrical box – and don't protrude past the wall
- Mounting wings hold boxes securely against wall when screws are tightened
- Fast, easy, convenient – saves time and money!
- Paintable trim plate
- 18.0 cubic inch recessed boxes

TV Bridge™ Complete, easy-to-install TV Box Kit



**Secure.
Paintable.
Looks
Great.**

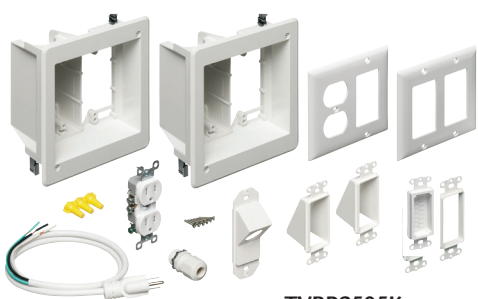

TVBR2505K

CATALOG NUMBER	UPC/DCI/NAED MFG #01 8997	DESCRIPTION TV BRIDGE™	UNIT PKG	STD PKG
TVBR2505K	09658	TWO 18.0 cu inch recessed boxes	1	1
TVBR2505KGC	09018	TWO 18.0 cu inch recessed boxes with ground clip for Canada	1	1

PATENTED



Wires
stay
hidden
behind
wall

What's included:

- (2) TVBR505 recessed dual-voltage boxes
- (2) cover plates
- (2) CED1 entrance hoods
- (1) CED13 cable entry device
- (1) CED130 cable entry device
- (1) KD4550 45° knockout device
- (1) tamper-resistant duplex receptacle
- (1) 6 ft. 14 AWG cord
- (1) LPCG50W cord grip
- Installation screws
- (3) wire nuts



Arlington®

PLASTIC Low Profile Box Kit for Flush TV Installations on Shallow Walls

FINISHED installation

Roomy 5" x 8" boxes accommodate multiple cables... Wires run behind wall

Low profile 1-1/4" deep recessed boxes

LOW PROFILE for Shallow Walls

Trim plate

Device & cover

7 ft cable

TVL2508K

Mounting wing screws

Brackets for tying off wire

Arlington's all-inclusive **Low Profile TV BRIDGE™ KIT is ideal for TV installations on 1/2" or 5/8" drywall with wall cavity depths as shallow as 3/4" (and deeper). Applications in new work or retrofit include:**

- Furring strips on concrete block walls
- 2x2, 2x3 and 2x4 or larger studs

A low profile box is also helpful when plumbing or other obstructions run behind the wall.

- Ample room inside for multiple cables, with brackets for tying them off
- Plug stays inside upper box so TV mounts closer to the wall
- Mounting wing screws hold boxes securely in wall
- Kit includes all you need to install a TV close to a wall and connect to additional components

TVL2508K Installation...

- 1 After locating position of TV and installing mounting bracket, cut holes for upper and lower boxes in a clear space in the same stud bay.

Power source

* Mounting bracket not shown

LOWER Box...

- 2 Position lower box so that supplied cord reaches existing receptacle (or power conditioner). Feed NM cable connector from lower box, behind the wall, to upper box opening. Also pull low voltage cable and speaker wire.
- 3 Tighten four wing screws to install box/power cord assembly.

PATENTED

UPPER Box...

- 4 Install trim plate. Pull NM cable through connector. Install box in hole by tightening wing screws (see 3).
- 5 Attach electrical receptacle to receptacle mounting bracket.
- 6 Attach receptacle mounting bracket.

No need to run power from panel box - or to cut into framing members

CATALOG NUMBER	UPC/DEI/NAED MFG. #018997	DESCRIPTION LOW PROFILE TV BRIDGE KIT	UNIT/STD PKG
TVL2508K	52305	5" x 8" power/low voltage	1/4
TVL2508KGC	52306	5" x 8" power/low voltage w ground clip for Canada	1/4

PLASTIC Low Profile Box • Weatherproof EXTRA DUTY Cover for Outdoors

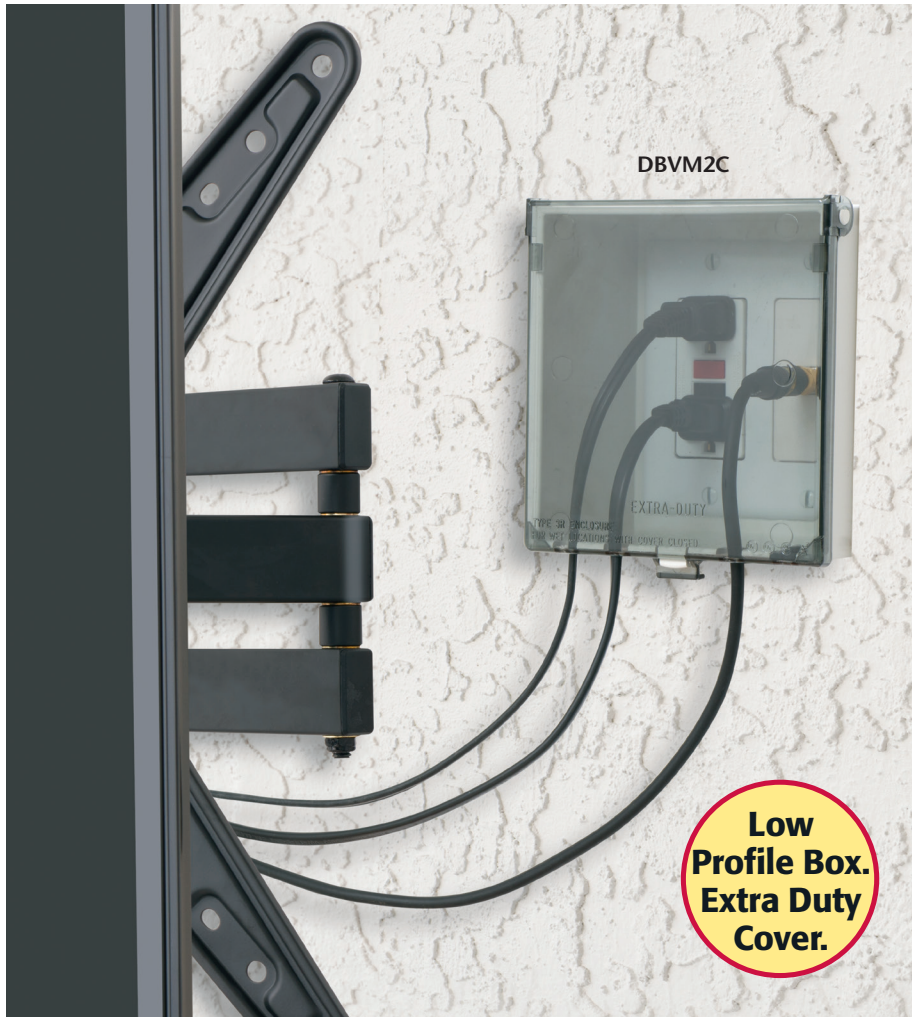

Low Profile Two-Gang IN BOX®

Arlington's UV rated **Two-Gang Low Profile IN BOX®** is designed for exterior flat surfaces: masonry, retrofit and vinyl siding construction.

Our non-metallic combination power/low voltage two-gang IN BOX® is the secure, weatherproof way to install two outlets or devices *or to mount a TV* on an exterior wall.

It features power in one side; and either a second gang of power or low voltage in the other. It's perfect for exterior installations of an outlet and a switch, or two switches, or Class 2 wiring of satellite or cable TV.

- No gaskets required
- Paintable white – or clear cover
- Non-metallic 22.0 cu. inch box in three styles – for stucco, vinyl siding and retrofit, for example flat siding or T111
- Meets NEC 406.9(b), NEMA 3R and CEC Rule 26-702 where a weatherproof-in-use cover is required for 15 or 20 amp receptacles installed outdoors

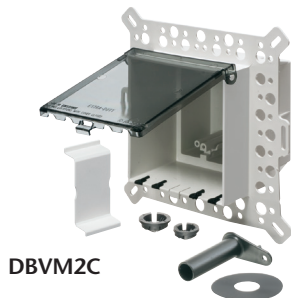

DBVM2C



DBVR2W



DBVS2C

CATALOG NUMBER	UPC/DCI/NAED MFG. #018997	DESCRIPTION/USE/COVER COLOR TWO-GANG RECESSED IN BOX®	UNIT PKG	STD PKG
DBVM2C	03962	Masonry/Textured surfaces • Vertical/Clear	1	4
DBVM2W	03963	Masonry/Textured surfaces • Vertical/White	1	4
DBVR2C	03964	Flat surfaces/Retrofit • Vertical/Clear	1	4
DBVR2W	03965	Flat surfaces/Retrofit • Vertical/White	1	4
DBVS2C	03960	Vinyl Siding • Vertical/Clear	1	4
DBVS2W	03961	Vinyl Siding • Vertical/White	1	4

Add suffix "GC" to catalog number when ordering box with ground clip for use in Canada (i.e. DBVM2CGC).

PATENTED. ADDITIONAL PATENTS PENDING.



Listed for Canada



Arlington®

STEEL Recessed TV Boxes for Use with Metal Cable

TV BOX™

Designed for use in commercial and other construction where metal cable is used, Arlington's STEEL combination TV BOX™ provides power and/or low voltage in one or more openings.

The recessed design of these steel boxes keeps plugs and connectors inside the box. Connections don't extend past the wall, so TVs mount flush.

STEEL RECESSED POWER & LOW VOLTAGE COMBO BOXES

Steel TV BOX... single-, two-, three- and four-gang, and 8x10.

- Steel box with non-metallic paintable white trim plate
- Easy to install, secure installation
Mounting wings hold boxes secure in the wall in retrofit projects – Boxes screw-mount to stud in new construction
- Optional cover for unused boxes sold separately
- cULus Listed

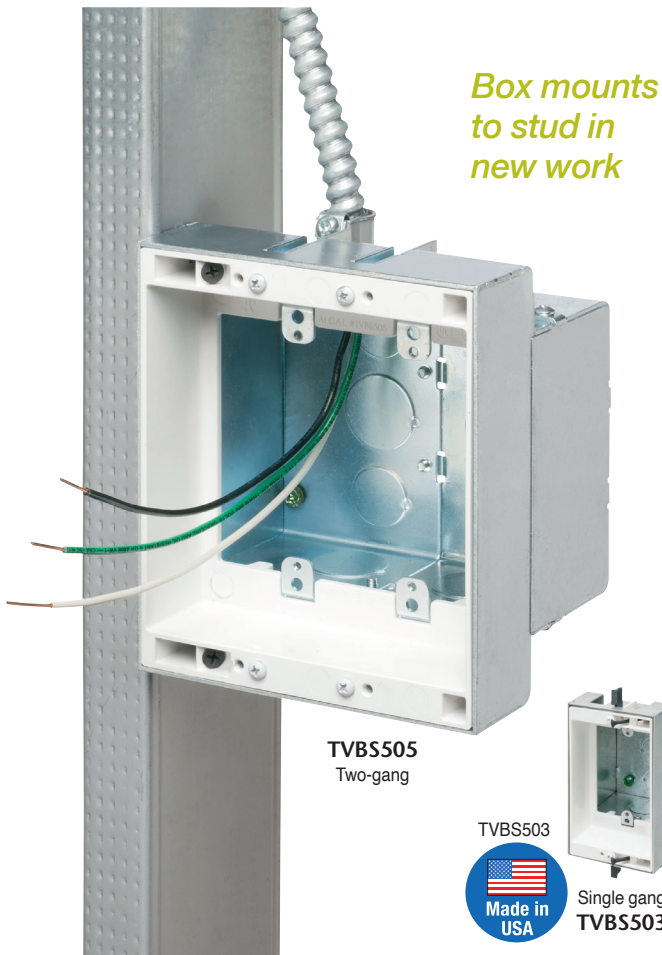

BLANK COVERS



HOME THEATER/AV • New or Retrofit

STEEL Recessed TV Boxes for Use with Metal Cable

Steel TV BOX™ Installation Existing Construction



1 Cut hole. Use enclosure, without trim plate, as a template.



2 Pull cable. Insert box in hole. Tighten mounting wing screws to hold box securely against wall.

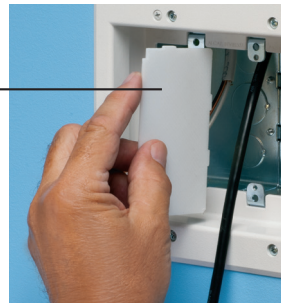

Note Install voltage separator for power and low voltage.



3 Install devices, then the wall plates.

Steel TV BOX™ Installation New Construction

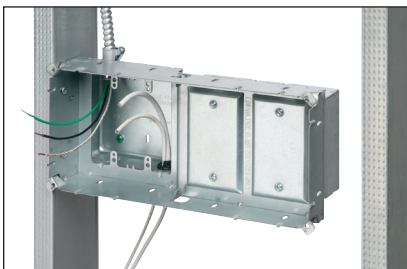

1 Attach box to stud. Pull wire.



2 After drywall is installed, add trim plate. Install enclosure assembly to wall with outer screws.



3 Install voltage separator.



4 Install devices and plates.

CATALOG NUMBER	UPC/DCI/NAED MFG. #018997	DESCRIPTION FOR USE W/METAL CABLE	UNIT PKG	STD PKG
TVBS503	38112	Single-gang, steel box	1	4
TVBS505	37955	Two-gang, steel box w/ white non-metallic trim plate	1	4
TVBS507	37956	Three-gang, steel box w/ white non-metallic trim plate	1	4
TVBS613	09633	Two-gang, steel, power/low voltage (white trim plate) (Plus two low voltage mounts)	1	1
TVBS810	09757	8" x 10" Steel power/low voltage box	1	1
DVFR3C	14337	White non-metallic blank cover for two-gang TVBS505	10	10
TVB613C	09631	White non-metallic blank cover for 13" TVBS613	5	5
DVFR3C	10570	White non-metallic blank cover for three-gang TVBS507	10	10

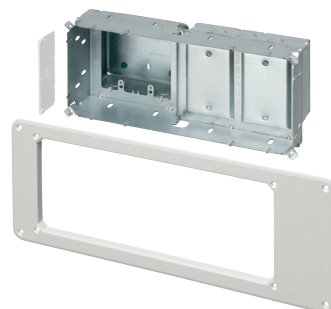

PATENTED



Arlington®

SPECIALTY BOXES

SliderBar™ • QuickLATCH™ ...The Ultimate Mounting System

Arlington's winning combination – steel **SLIDERBAR™** and **QuickLatch™** pipe hangers – offers the easy, SECURE way to mount conduit between wood or metal studs.

Adjustable, screw-on **SLIDERBAR** allows positioning of conduit, in multiple sizes *anywhere in the stud cavity*.

18" **SL18** fits between studs spaced 12 to 18 inches. The 24" **SL24** fits 15 to 24 inch on center spacing.

Corrosion-resistant, one-piece **QUICKLATCH™** pipe hanger mounts conduit or pipe to SliderBar in a quick, extra-secure installation.

Non-metallic QuickLatch is UV rated for outdoor use and Listed for environmental air handling spaces.

- For rigid, EMT, liquid-tight, flex, ENT, copper tubing or pipe

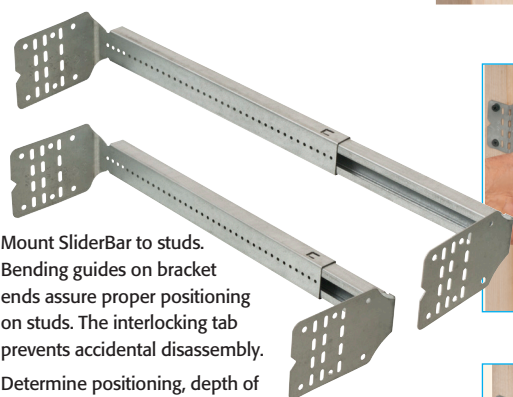

1 Mount SliderBar to studs. Bending guides on bracket ends assure proper positioning on studs. The interlocking tab prevents accidental disassembly. Determine positioning, depth of conduit and bracket.

2 Install QuickLatch pipe hanger on SliderBar with #8 sheet metal screws through pre-punched pilot holes.

3 Press conduit/pipe into QuickLatch to lock securely in place.

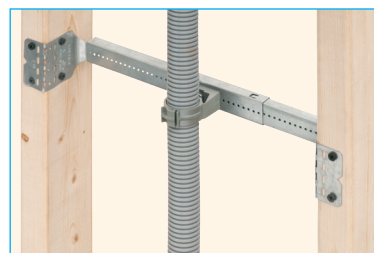
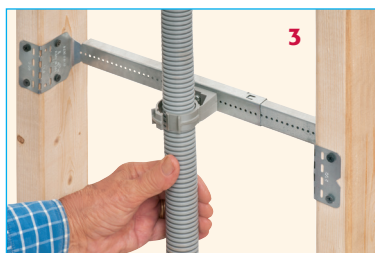
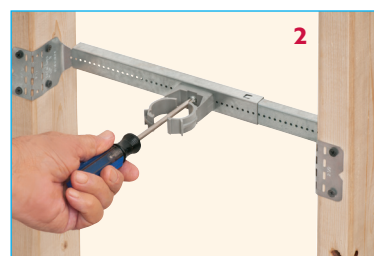
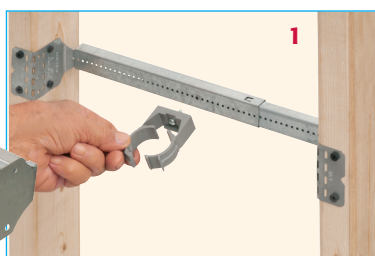
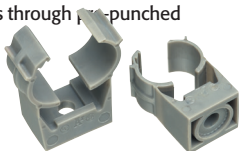

SliderBar™

CATALOG NUMBER	UPC/DCI/NAED MFG. #018997	DESCRIPTION BAR WITH PRE-BENT ENDS	UNIT PKG	STD PKG
SL18	00929	Adjustable 18" SliderBar™ Fits between studs spaced 12" to 18" oc	25	25
SL24 *	00920	Adjustable 24" SliderBar™ Fits between studs spaced 15" to 24" oc	25	25
* UL Listed only				



QuickLatch™

CATALOG NUMBER	UPC/DCI/NAED MFG. #018997	DESCRIPTION NON-METALLIC PIPE HANGER	STD PKG
NM2010	54516	for 3/4" EMT	100
NM2020	54517	for 1" EMT	100
NM2030	54528	for 1-1/4" EMT	100



Arlington®



Shipped with factory-installed hinged covers, Arlington's **Non-metallic Enclosure Boxes** meet NEMA 3R requirements for outdoor use *with hinge on top*. They're the perfect solution to protecting and securing power backups, security devices and other valuable equipment outdoors or inside.

Made of heavy-duty, UV rated non-metallic material, and available in a variety of sizes - our boxes come with or without a back plate for easy access to components, even after the box is installed. Remove the plate for maintenance work, or to change batteries

- All sizes available with or without a back plate
- 7" x 8" x 3.5"
- 11" x 11" x 3.5"
- 12" x 12" x 4"
- **12" x 12" x 6" NEW!**
- Meets NEMA Type 3R Requirements
- Available in gray and black
- Convenient 1/2" and 3/4" knockouts
- 'Lockable' with a knockout for a cam lock (EBL1 sold separately) or a padlock latch



LOCKABLE

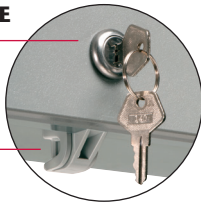

EB1212BP
with Back Plate

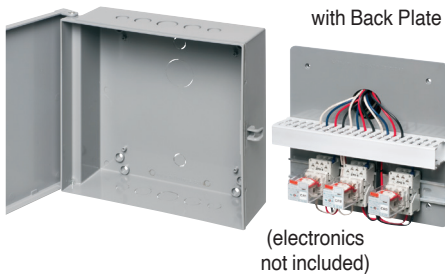

EB1212BL
Hinge on side
for indoor use



NEMA 3R RATED for OUTDOOR*
and INDOOR USE

* For Outdoor Use
box must be mounted
with hinge
on top.



Gray Enclosure Boxes *Add suffix BL to order in Black

CATALOG NUMBER	UPC/DCI/NAED MFG. #018997	DESCRIPTION GRAY ENCLOSURE BOX	UNIT PKG	STD PKG
EB0708	12672	7" x 8" x 3.5"	1	4
EB0708BP	23170	7" x 8" x 3.5" w/ Back Plate	1	4
EB1111	12670	11" x 11" x 3.5"	1	5
EB1111BP	23171	11" x 11" x 3.5" w/ Back Plate	1	5
EB1212	12671	12" x 12" x 4"	1	5
EB1212BP	23155	12" x 12" x 4" w/ Back Plate	1	5
EB12126	23172	12" x 12" x 6"	1	5
EB12126BP	23173	12" x 12" x 6" w/ Back Plate	1	5
EBL1	11400	Cam Lock	1	10



SPECIALTY BOXES • Retrofit

Versatile 4x4 Box for Fire Alarms, Signaling and other Devices

Arlington's FSR404 series **4x4 non-metallic and steel boxes** ship ready to install!

These versatile boxes feature *two* hole-pattern configurations in the same 4x4 box – 6/32 for a two-gang device, and 8/32 for a 4 inch square. And 1/2 and 3/4 inch knockouts.

Use the red boxes – in plastic or steel – for fire alarm or signaling device installations where required by local code.

The spring steel clip secures the box in the wall. It's set for 1/2 or 5/8 inch drywall, but for thicker walls installers can modify the depth by bending the bracket and breaking it along the perforations.

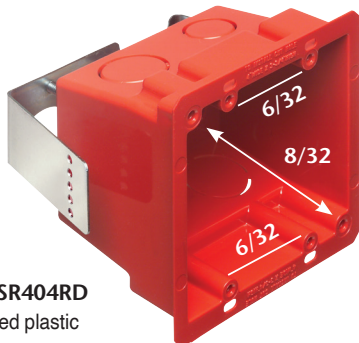
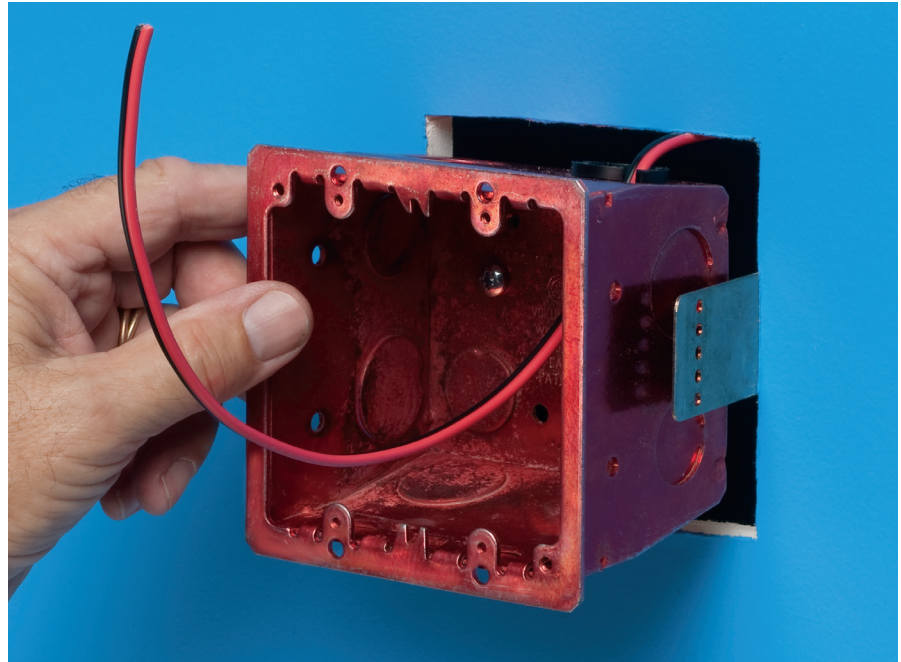
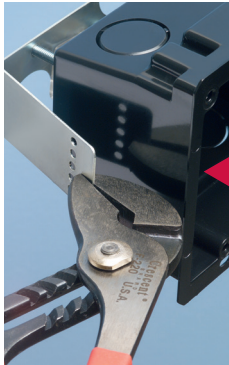

FSR404RD
Red plastic



**TWO HOUR
FIRE RATING**

FSR404BL
Black plastic

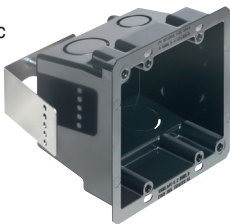

PATENTED



Arlington®



Listed for
Canada

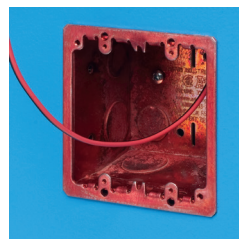
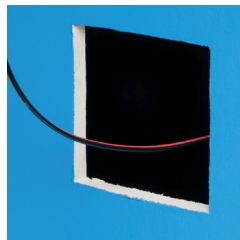

Easy Fire Alarm Installation in 4x4 Box

CATALOG NUMBER	UPC/DCI/NAED MFG. #018997	DESCRIPTION 4X4 BOX	LISTING	UNIT PKG	STD PKG
FSR404RD	00598	RED 4x4 - Non-Metallic	UL Listed • 2-Hr Fire Rating	25	25
FSR404BL	00596	BLACK 4x4 - Non-Metallic	UL Listed • 2-Hr Fire Rating	25	25
FSR404SRD	00599	RED 4x4 - Steel	cULus Listed	25	25
FSR404S	00597	PLATED 4x4 - Steel	cULus Listed	25	25
FSR404SD	00600	4x4 Box Divider - Steel	N/A	25	25

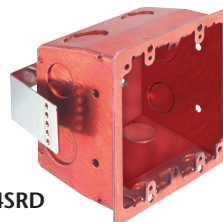

FSR404SRD
Red steel

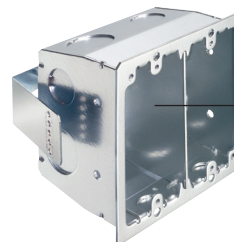

with divider
FSR404SD installed

FSR404S
Plated steel



CAM-BOX™ KIT Sturdy Security Camera Installation on a Suspended Ceiling



1 Cut hole in the ceiling with 4" hole saw.



2 Align box as necessary. Tighten mounting wing screws.



3 Wrap drop wire twice through loop on top of box and around a framing member above ceiling. Wrap wire around itself six times minimum in both instances.



4 Install supplied NM94 cable connector (1/2" or 3/4").



5 Install mounting bracket to inside of box.

Note: Mount cameras with base diameter of 4.5" to 7" directly to the box flange *no mounting plate required.*



6 Mount camera to mounting plate. Place assembly on bracket. Turn clockwise to lock. Install set screw.

Done! Secure camera installation – No sagging ceiling.

Use Arlington's **CAM-BOX™ KIT** to install any security camera, with base diameter up to 7", on a suspended or drywall ceiling panel. For power or low voltage, it installs FAST with a 4" hole saw.

It's a tested assembly that holds up to 50 lbs, and it fits any security camera hole pattern because you drill the holes in the mounting plate. Larger cameras, with a base diameter between 4.5" to 7", mount directly to the paintable white plastic box flange.

CAM-BOX™ KIT has features that deliver a secure, functional camera installation... a drop wire for overhead support, mounting wing screws for secure attachment of the box to the ceiling, and a mounting bracket and plate that rotate in either direction for proper positioning of the camera.

Unlike most multi-piece assemblies, CAM-BOX™ KIT is rated for:

- Up to 50 lbs on a suspended ceiling or drywall ceiling in combination with a drop wire for support
- Up to 10 lbs on a drywall ceiling without drop wire (not rated for fixtures)
- Up to 7 lbs on walls



FLC430 CAM-BOX™ KIT Plastic

Includes 27.0 cu in **plastic box** with 1/2 and 3/4 inch knockouts, drop wire, (2) NM94 cable connectors (plastic box only) and mounting bracket and plate for camera

FLC430S CAM-BOX™ KIT Steel

Includes 17.0 cu in **steel box**, with 1/2 and 3/4 inch knockouts, drop wire, mounting bracket and plate for camera

CATALOG NUMBER	UPC/DCI/NAED MFG. #018997	DESCRIPTION CAM-BOX™ KIT	MATERIAL	CU IN	UNIT PKG	STD PKG
FLC430	09742	Security Camera Mounting Kit	Plastic box	27.0	1	10
FLC430S	09743	Security Camera Mounting Kit	Steel box w/ plastic flange	17.0	1	10

PATENTED



Arlington®

SECURITY • Camera Mounting Kit for Wall or Ceiling Mount

CAM-KIT™

Secure, Universal Mounting to 3.5" and 4" Boxes

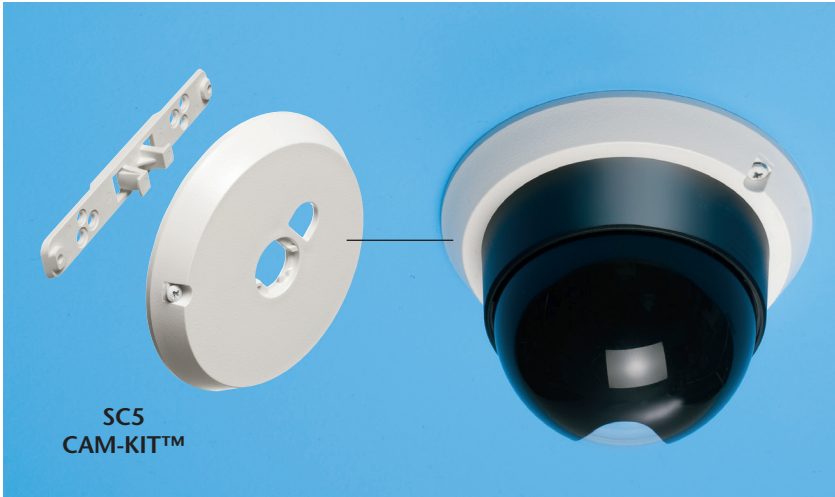

CATALOG NUMBER	UPC/DCI/NAED MFG. #018997	DESCRIPTION	COLOR/MATERIAL	UNIT PKG	STD PKG
SC5	18058	Security camera mounting kit	White Plastic	1	20
SC5BL	18220	Security camera mounting kit	Black Plastic	1	20



Arlington's non-metallic **CAM-KIT™**, security camera mounting kit, offers the easy, secure way to install a security camera on a ceiling or wall.

- Fits ANY camera hole pattern – you drill the holes in the mounting plate
- Works with 3.5" and 4" fixture boxes, single-gang device boxes – and Arlington's FL430 fixture box
- Secure attachment of low voltage or power security cameras to ceiling or wall-mounted boxes
- Includes a universal bracket, 5" mounting plate and mounting screws



1 Attach SC5 bracket to box.



2 Place assembly on bracket. Turn clockwise to lock. Install set screw.

PATENTED



Round Low Voltage Mounting Bracket

Mounting Bracket for Low Voltage Detector Installations

Arlington's 4" diameter **Round Low Voltage Mounting Bracket** is perfect for low voltage smoke detector installations in existing construction.

- For smoke detectors, carbon monoxide detectors, cameras and more – or any low voltage products that mount to a standard 4" fixture box
- Mounting wing screws hold bracket secure
- Adjustable depth – fits 1/4" to 1-1/2" wall or ceiling thickness
- Fast, easy solution to mounting



CATALOG NUMBER	UPC/DCI/NAED MFG. #018997	DESCRIPTION FOR EXISTING CONSTRUCTION	UNIT PKG	STD PKG
LVR1	58185	4" Round Mounting Bracket	25	25

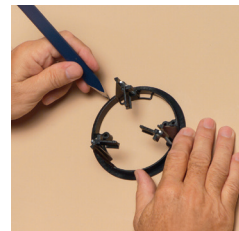

1 Bracket is template for opening.



2 Pull cable and tighten mounting wing screws to hold bracket secure.



3 Install mounting plate per manufacturer's instructions.



4 Done! Fast, easy installation.



Mount Security Cameras *and more*, in Dry, Damp or Wet Areas



Soffit or eave mount



Wall mount



...with threaded openings for additional installations

Arlington's **8161 series boxes** offer flexible solutions to mounting security cameras, detectors and other items outdoors!

You can install a power or low voltage security camera – with mounting holes spaced wider than 4.5" apart – right on the box and mount it to a wall or ceiling.

These non-metallic boxes support security cameras, electrical accessories and fixtures *up to 50 lbs* on ceilings – and *up to 10 lbs* on a wall. The positionable threaded openings allow you to install a camera where you need it now; then install additional cameras, etc. later.

- Use indoors or outdoors. For dry, damp or wet location
- UV rated for long outdoor life



8161TR

8161TR installation photos shown with SC5 CAM-KIT™ installed Security cameras not included



8161CB



8161BP on down rod

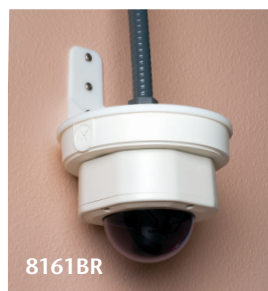

8161BR

For cameras with base diameter LESS THAN 4.5" use our SC5 camera mounting kit (not included). See opposite page 32.



PATENTED

SC5

Catalog NUMBER	UPC/DCI/NAED MFG. #018997	Description PLASTIC BOX W/ THREADED OPENINGS	Weight Rating /MOUNTING	Unit PKG	Std PKG
8161TR	00878	Camera mount for Flat wall/Ceiling	10 lb/wall	1	10
8161BR	08881	Camera mount for Offset on wall	50 lb	1	10
8161BP	08880	Camera mount for Pendant/Down rod based	50 lb/down rod	1	10
8161CB	01530	Camera mount for Corner-mounting	50 lb/corner	1	10
8161PM	09020	Camera mount for Pole-mounting	50 lb/pole	1	10

Add suffix "GC" to catalog number when ordering with ground clip for use in Canada (i.e. 8161TRGC).



Arlington®

FLOOR BOXES

Combo Boxes with Power/Low Voltage in the Same Box

FLOOR BOX KITS

KITS • BOXES • TRIM KITS • ACCESSORIES

Arlington offers a full line of Floor Box Kits, Boxes, Cover Trim Kits and Accessories for nearly any job site condition or application – new concrete, new construction and retrofit projects.

Our FLOOR BOX KITS offer installers the competitively priced, convenient way to install a receptacle in the floor – with a cover that’s flush with the floor.



The floor boxes in these kits are combination boxes with power and low voltage in the same box. For added convenience many of our boxes and covers are interchangeable with other manufacturers' products.

We offer non-metallic or steel boxes...with metal or non-metallic covers in a variety of colors and finishes!

Visit our website to see the entire line: www.aifittings.com

Recessed IN BOX® Cover Kits for 4.5" Round Concrete Floor Boxes

w Low Voltage Divider

Metallic covers

FLBC4560DMB • FLBC4560DNL

Non-Metallic covers

FLBC4560DBL • FLBC4560DBR

FLBC4560DCA • FLBC4560DGY

FLBC4560DLA

w Low Voltage Divider, ultra-thin flange and cover

Metallic covers

FLBC4580MB

FLBC4580NL



for 5.5" Round Concrete Boxes



w Low Voltage Divider, two installed duplex receptacles

Plated cover

FLBC5570AB

FLBC5570MB

FLBC5570NL

Powder-coated cover

FLBC5570BL

FLBC5570BR

FLBC5570LA

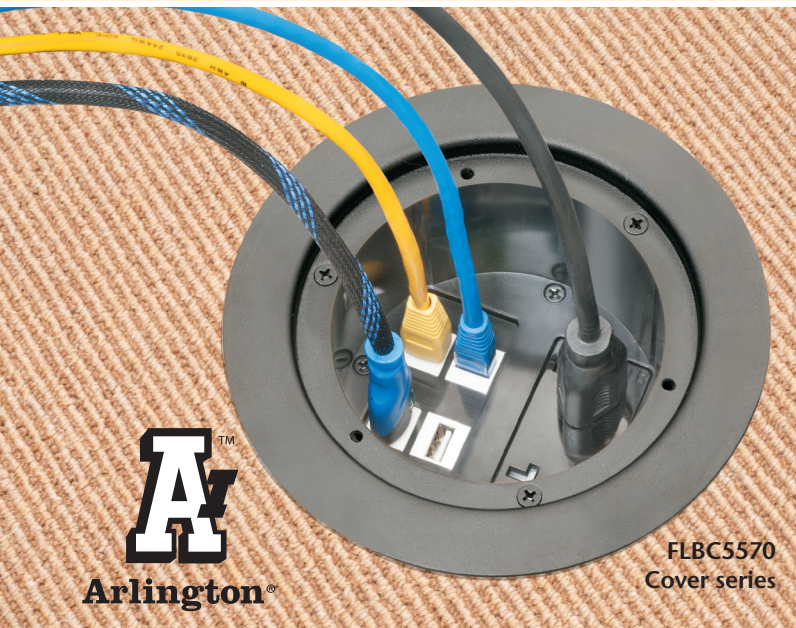

FLBC5570 Cover series

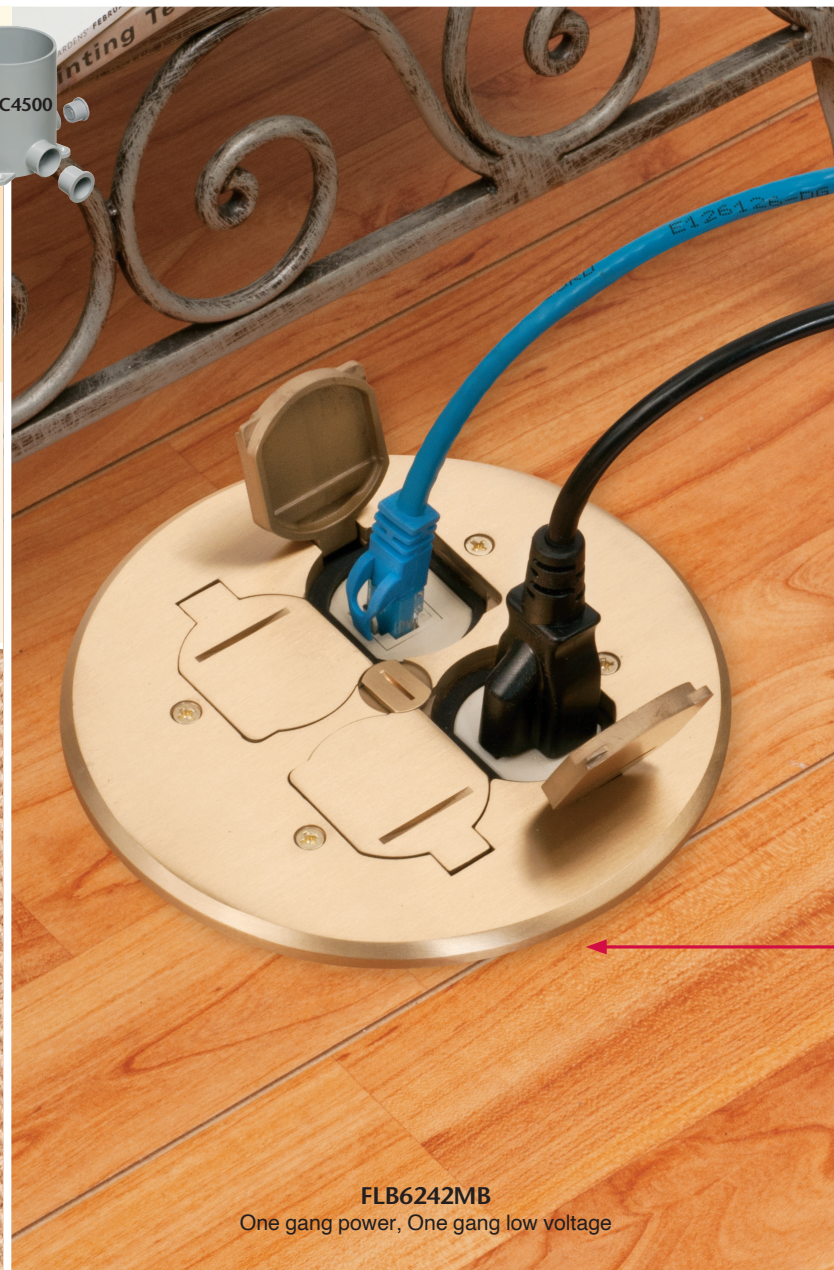

FLB6242MB One gang power, One gang low voltage

Plastic IN BOX® Floor Box Kits

Two low voltage openings w built-in divider. Recessed wiring device. Ultra thin stamped steel blank and slotted round covers. For existing floors.



Here's the easy solution to installing a receptacle and low voltage connections in an existing floor.

Offered in six finishes, Arlington's FLBR5420 series RECESSED FLOOR BOX KITS have two low voltage openings, an ultra-thin stamped steel flange, and flush-to-the-floor in-use and blank covers.

The thin flange and recessed wiring device reduce trip hazards caused by plugs protruding from the box. And you can have power and low voltage in the same box without a divider.

CATALOG NUMBER	UPC/DCI/NAED MFG. #018997	COVER FINISH/COLOR	DESCRIPTION	UNIT PKG	STD PKG
PLATED ZINC COVER • PLATED STEEL FLANGE					
FLBR5420AB	21269	Antique Bronze-plated	24.5 cu in non-metallic box	1	1
FLBR5420MB	21191	Brass-plated	24.5 cu in non-metallic box	1	1
FLBR5420NL	21192	Nickel-plated	24.5 cu in non-metallic box	1	1
POWDER COATED ZINC COVER • POWDER COATED STEEL FLANGE					
FLBR5420BL	21266	Black	24.5 cu in non-metallic box	1	1
FLBR5420BR	21267	Brown	24.5 cu in non-metallic box	1	1
FLBR5420LA	21268	Light Almond	24.5 cu in non-metallic box	1	1

Add suffix 'GC' to order with Ground Clip in Canada



FLBR5420BR Recessed Plastic Power/Low Voltage Combo Box • Flush to floor slotted in-use cover

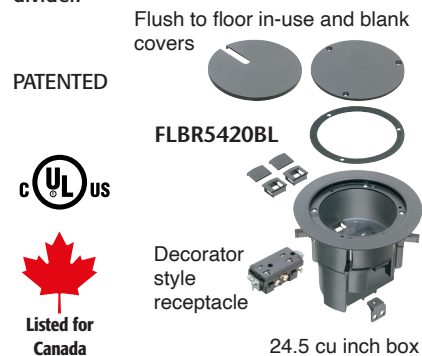

PATENTED



24.5 cu inch box

Steel Combo Power/Low Voltage Floor Box Kits

Installed low voltage divider. Square gasketed metal cover with flip lids. For new and existing floors.

CATALOG NUMBER	UPC/DCI/NAED MFG. #018997	SQUARE METAL COVER, 4 FLIP LIDS	DESCRIPTION	UNIT PKG	STD PKG
FLB5552MB	22050	Brass	5.018" Square Cover	1	4
FLB5552NL	22051	Nickel-plated	Two-gang Steel box w installed divider	1	4

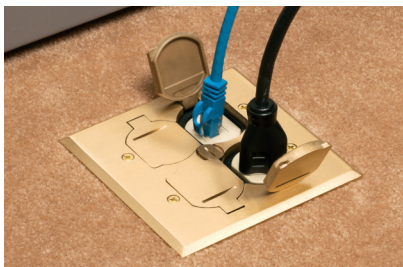

FLB5552MB Steel Power/Low Voltage Combo Box

FLB5552NL

FLB5552MB

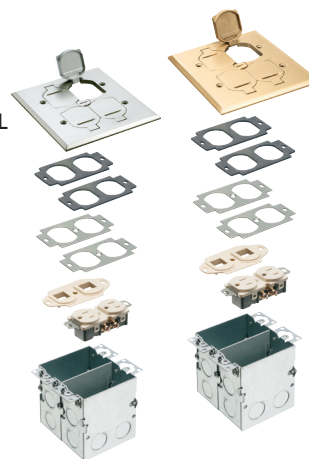

Steel Combo Power/Low Voltage Floor Box Kits

One low voltage device. One 110V receptacle. Round gasketed metal cover with flip lids. For new and existing floors.

CATALOG NUMBER	UPC/DCI/NAED MFG. #018997	ROUND METAL COVER, 4 FLIP LIDS	DESCRIPTION	UNIT PKG	STD PKG
FLB6242MB	22804	Brass	6" Diameter Cover,	1	1
FLB6242NL	22805	Nickel-plated	Two-gang Steel Box	1	1

FLB6242MB



Arlington®



Arlington designs and produces more than 85% of its innovative products in Scranton, Pennsylvania USA.



Arlington®

1 Stauffer Industrial Park
 Scranton, PA 18517
 800/233.4717
 Fax 570/562.0646
 www.aifittings.com

